

| CONTENTS | |
|----------------------|----------|
| Frost | page 5 |
| Conversion Chart | page 6 |
| Materials » Finishes | page 7 |
| Nova2 | page 8 |
| Unu | page 52 |
| Quadra | page 64 |
| Nova | page 102 |
| Mirrors & Shelves | page 120 |
| Handles | page 126 |
| Index | page 162 |
| Notes | page 166 |



FROST

Our passion for architectural hardware forms the basis of the establishment of our company FROST.

Early on, we ventured into a close cooperation with the young and progressive design company Bønnelycke mdd, Denmark. This cooperation has manifested itself in a solid structure ensuring stylistically consistent and focused designs reflecting the high quality, aesthetics and functionality for which Scandinavian designers are known worldwide.

The design of each product series logically incorporates the support material such as graphic identity, catalogues, packing and the website into the products, which is in complete agreement with FROST's philosophy of quality being more than just a stainless steel grade.

At FROST, we develop and manufacture bold and innovative product series and systems with an international touch for the furniture industry, the building industry and the trade industry.

Our product series range from handles for furniture and other inventory to kitchen and bathroom supplements and small finished furnishing products for wardrobes and hallways.

At FROST, we believe that quality is a combination of several factors: demand, analysis, design, prototyping, manufacturing, marketing end support.

When the issue is quality, we do not compromise !

Welcome to FROST's BOOK 2.

For further inspiration please visit www.frostdesign.dk



Stainless Steel » polished

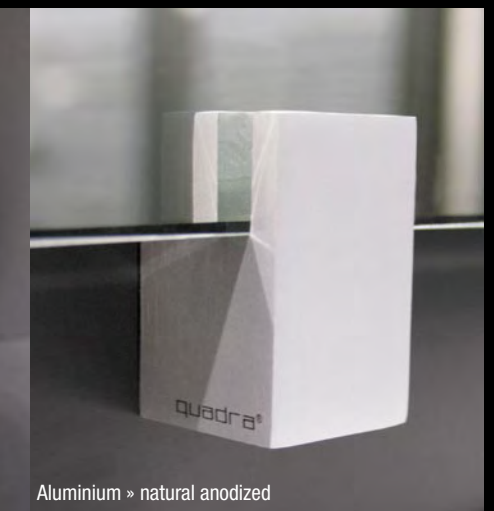

Aluminium » natural anodized



Zinc » matt chrome



Zinc / Brass » polished chrome

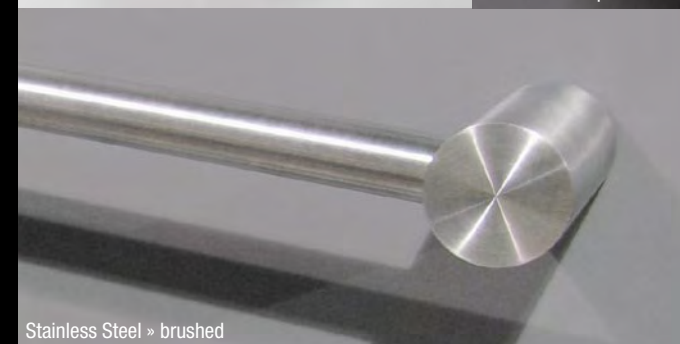

Stainless Steel » brushed



Zinc / Brass » brushed stainless

| CONVERSION CHART METRIC | | CONVERSION CHART ENGLISH | |
|-------------------------|-------------|--------------------------|-----------|
| Metric | English | English | Metric |
| 1 mm | 0.03937 in | 1 in | 2,54 cm |
| 1 cm | 0.3937 in | 1 foot | 0,3048 m |
| 1 m | 1.0936 yd | 1 yard | 0,9144 m |
| 1 km | 0.6214 mile | 1 mile | 1,6093 km |

| MATERIALS | FINISHES |
|-----------------|-------------------|
| Stainless Steel | brushed |
| Stainless Steel | polished |
| Zinc / Brass | brushed stainless |
| Zinc / Brass | polished chrome |
| Zinc | matt chrome |
| Aluminium | natural anodized |

Handles for furniture, bath furniture and kitchens.
 Kitchen accessories.
 Bathroom accessories.
 Wardrobe accessories.

Consistent details such as the shadow edge between the mounting surface and the product compliments the discreet and complete series. All elements are interpretations of the meeting between the stringent form and the cylindrical form - this is quite apparent on the hooks for the system.

Design: Bønnelycke mdd



Shelf 3 » N1918 » page 12

Hook For Bar 2 » N1906 » page 19

Kitchen Rail Extension » N1917-2 » page 10

Kitchen Roll Holder 1 » N1921 » page 16

Hook For Bar 3 » N1907 » page 18

Coffee Filter Holder 1 » N1920 » page 13

Knife Block » N1919 » page 13

Magnetic Knife Holder » N1919-1 » page 14

Kitchen Rail 2 » N1917-1 » page 11

KITCHEN RAIL EXTENSION

| | | |
|------------------|--|----------|
| Material | stainless steel | |
| Finish | brushed | polished |
| Item no. | N1917-2 | O1917-2 |
| Dimensions in mm | bar diameter $\phi 14$ / projection 40 / length 1000 | |

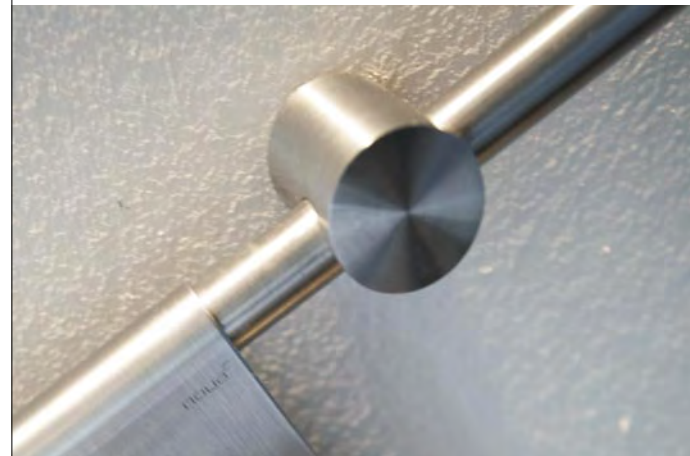
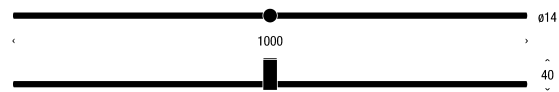

KITCHEN RAIL 2

| | | |
|------------------|---|----------|
| Material | stainless steel | |
| Finish | brushed | polished |
| Item no. | N1917-1 | O1917-1 |
| Dimensions in mm | bar diameter $\phi 14$ / projection 40 / c-c 1000 | |

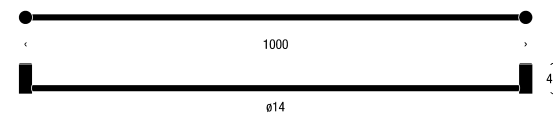



| SHELF 3 | |
|------------------|--|
| Material | stainless steel |
| Finish | brushed |
| Item no. | N1918 |
| Dimensions in mm | length 315 / height 230 / projection 160 |

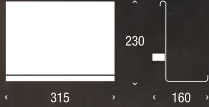

| COFFEE FILTER HOLDER 1 | |
|------------------------|--|
| Material | stainless steel |
| Finish | brushed |
| Item no. | N1920 |
| Dimensions in mm | length 200 / height 230 / projection 100 |

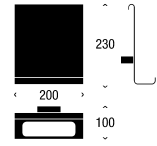

| KNIFE BLOCK | |
|------------------|--|
| Material | stainless steel / walnut |
| Finish | brushed / oiled |
| Item no. | N1919 |
| Dimensions in mm | length 315 / height 230 / projection 100 |

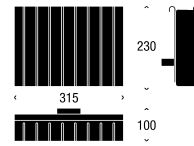

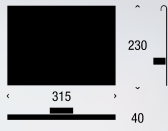
| MAGNETIC KNIFE HOLDER | |
|---|---|
| Material | stainless steel / magnetic rubber |
| Finish | brushed |
| Item no. | N1919-1 |
| Dimensions in mm | length 315 / height 230 / projection 40 |
|  | |





| KITCHEN ROLL HOLDER 1 | | KITCHEN ROLL HOLDER 6 | |
|-----------------------|--|-----------------------|--|
| Material | stainless steel | Material | stainless steel |
| Finish | brushed | Finish | brushed |
| Item no. | N1921 | Item no. | N1921-1 |
| Dimensions in mm | length 315 / height 230 / projection 200 | Dimensions in mm | length 365 / height 230 / projection 200 |
| | | | |

| KITCHEN ROLL HOLDER 2 | | |
|-----------------------|----------------------------|----------|
| Material | stainless steel | |
| Finish | brushed | polished |
| Item no. | N1923 | 01923 |
| Dimensions in mm | diameter ø120 / height 280 | |

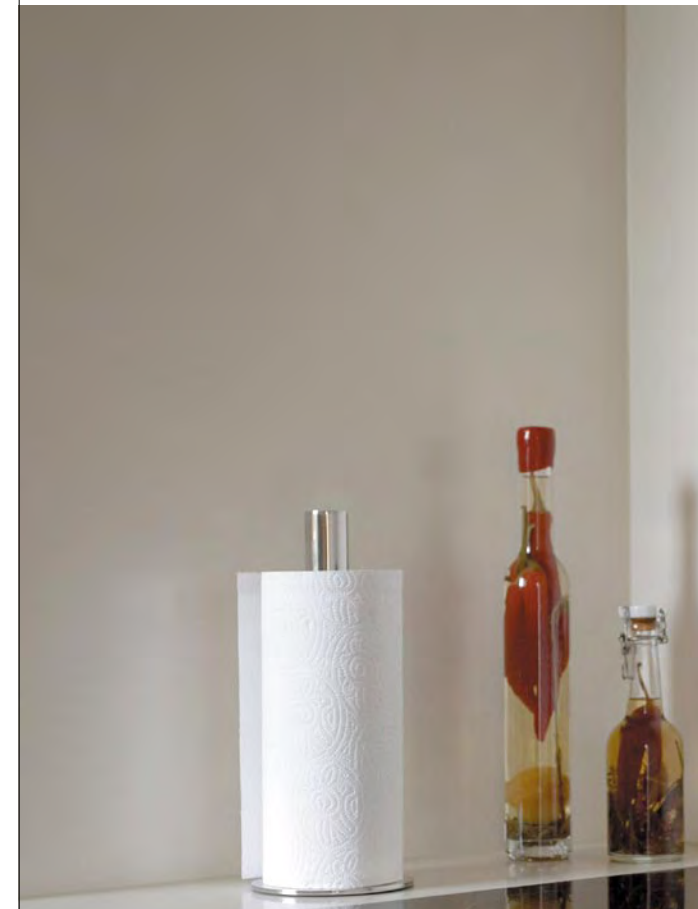
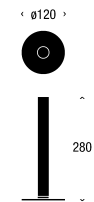

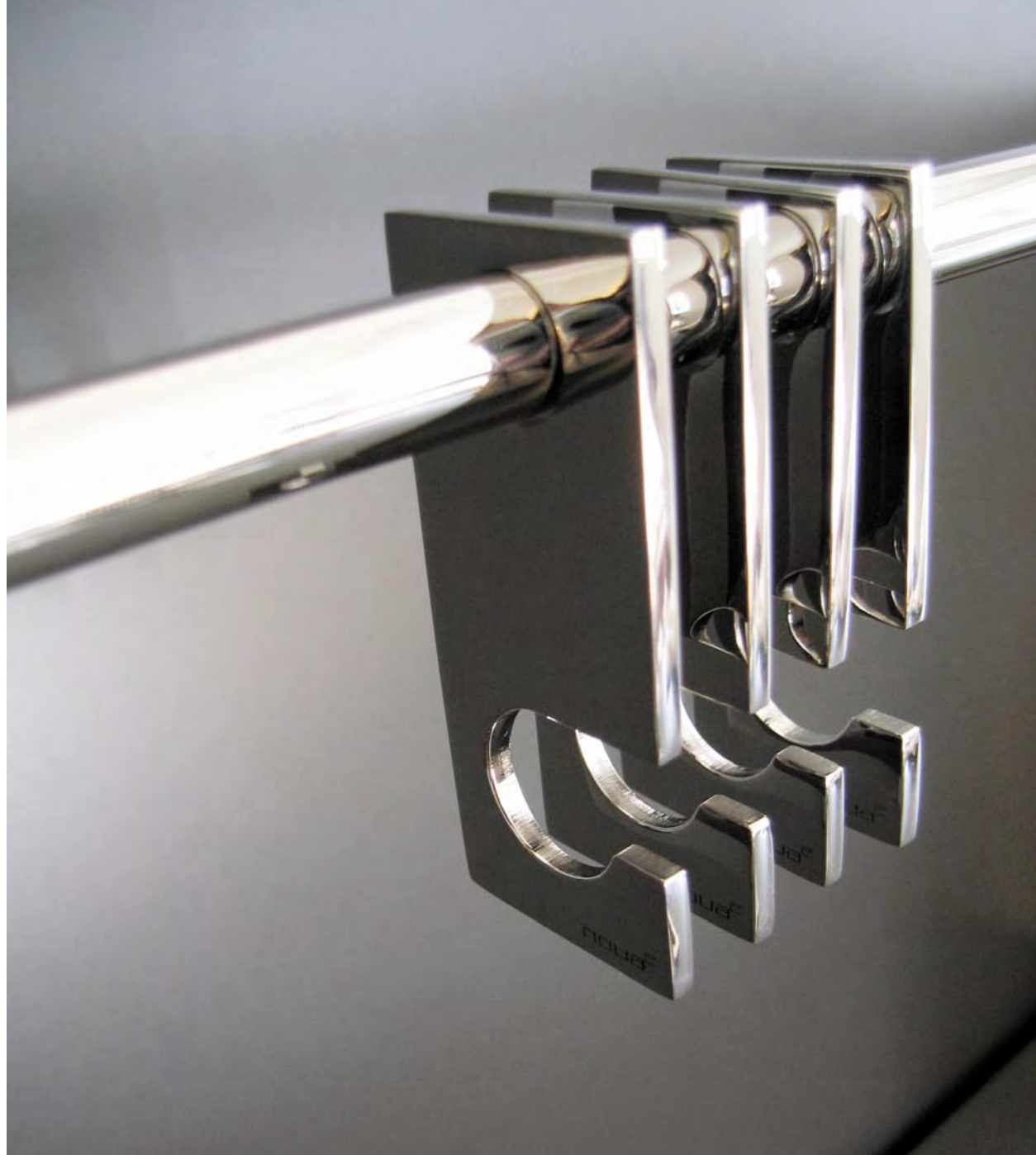

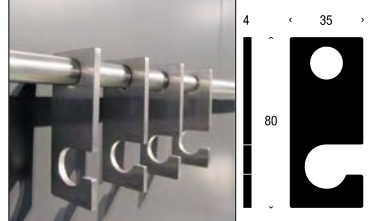
| HOOK FOR BAR 3 4 PCS. A SET | | |
|--|---|----------|
| Material | stainless steel | |
| Finish | brushed | polished |
| Item no. | N1907 | O1907 |
| Dimensions in mm | bar diameter \varnothing 14 / height 80 / thickness 4 | |
|  | | |



| HOOK FOR BAR 2 4 PCS. A SET | | |
|---|---|----------|
| Material | stainless steel | |
| Finish | brushed | polished |
| Item no. | N1906 | O1906 |
| Dimensions in mm | bar diameter \varnothing 14 / height 80 / thickness 4 | |
|  | | |



SOAP DISPENSER 1, TABLE

| | | |
|------------------|---------------------------|------------------|
| Material | stainless steel / plastic | |
| Finish | brushed / black | polished / black |
| Item no. | N1926 | O1926 |
| Dimensions in mm | diameter ø60 / height 166 | |

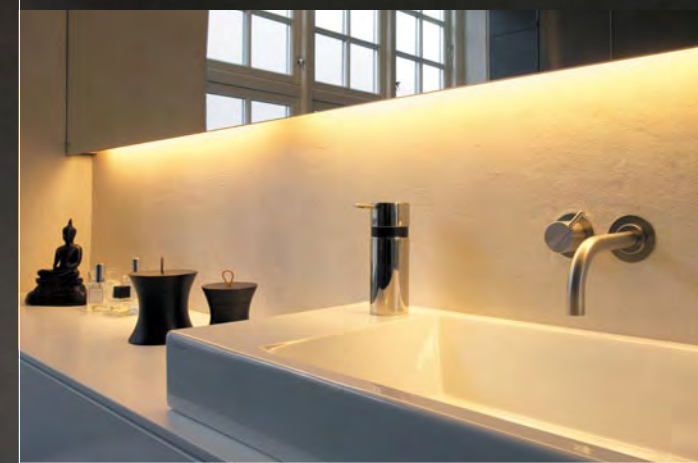



SOAP DISPENSER 3, WALL

| | | |
|------------------|---|----------|
| Material | stainless steel | |
| Finish | brushed | polished |
| Item no. | N1939 | O1939 |
| Dimensions in mm | diameter \varnothing 60 / height 188 / projection 104 | |

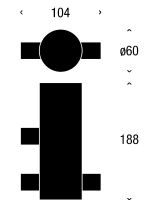

| TOILET BRUSH 2, WALL REPLACEABLE BRUSH | | |
|--|--|----------|
| Material | stainless steel | |
| Finish | brushed | polished |
| Item no. | N1911 | O1911 |
| Dimensions in mm | diameter ø89 / height 438 / projection 127,5 | |
| | | |



| TOILET BRUSH 1, FLOOR REPLACEABLE BRUSH | | |
|---|---------------------------|----------|
| Material | stainless steel | |
| Finish | brushed | polished |
| Item no. | N1910 | O1910 |
| Dimensions in mm | diameter ø89 / height 438 | |
| | | |



| TOWEL RING 1 | | |
|------------------|---|----------|
| Material | stainless steel | |
| Finish | brushed | polished |
| Item no. | N1913 | O1913 |
| Dimensions in mm | length 254 / height 134 / projection 40 | |
| | | |



| TOWEL RACK | | |
|------------------|--|----------|
| Material | stainless steel | |
| Finish | brushed | polished |
| Item no. | N1914 | O1914 |
| Dimensions in mm | length 457,5 / height 86,5 / projection 57,5 | |
| | | |



| BATH GRIB | | |
|------------------|---|----------|
| Material | stainless steel | |
| Finish | brushed | polished |
| Item no. | N1934 | O1934 |
| Dimensions in mm | bar diameter \varnothing 16 / projection 62 / c-c 300 | |

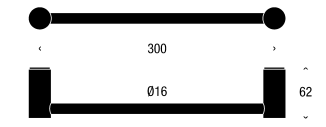

| TOWEL BAR 5 | | |
|------------------|---|----------|
| Material | stainless steel | |
| Finish | brushed | polished |
| Item no. | N1916-3 | O1916-3 |
| Dimensions in mm | bar diameter \varnothing 14 / projection 72 / c-c 800 | |

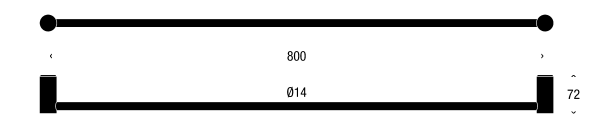

| TOWEL BAR 6 | | |
|------------------|--|----------|
| Material | stainless steel | |
| Finish | brushed | polished |
| Item no. | N1916-4 | O1916-4 |
| Dimensions in mm | bar diameter \varnothing 14 / projection 122 / c-c 800 | |

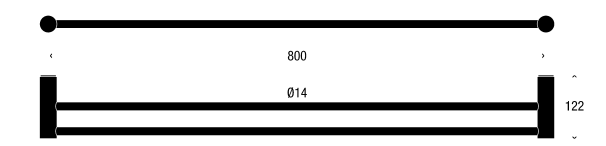

| TOWEL BAR 3 | | | TOWEL BAR 4 | | |
|------------------|---|----------|------------------|--|----------|
| Material | stainless steel | | Material | stainless steel | |
| Finish | brushed | polished | Finish | brushed | polished |
| Item no. | N1916-1 | O1916-1 | Item no. | N1916-2 | O1916-2 |
| Dimensions in mm | bar diameter \varnothing 14 / projection 72 / c-c 600 | | Dimensions in mm | bar diameter \varnothing 14 / projection 122 / c-c 600 | |

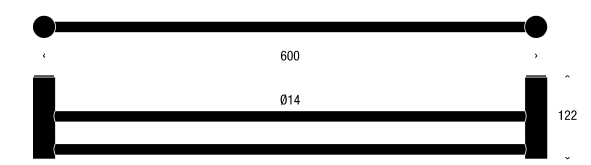
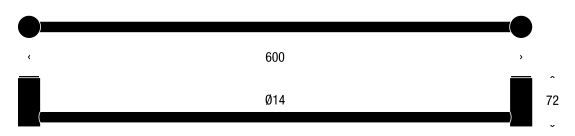

TOILET ROLL HOLDER 2

| | | |
|------------------|---------------------------------|----------|
| Material | stainless steel | |
| Finish | brushed | polished |
| Item no. | N1912 | 01912 |
| Dimensions in mm | height 167,5 / projection 118,5 | |

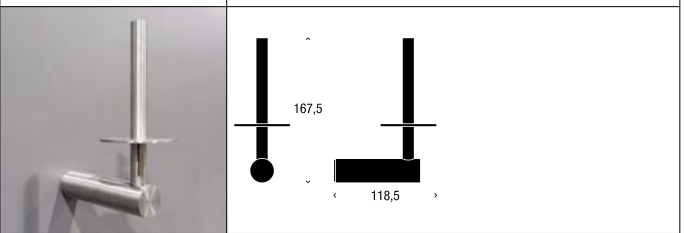

TOILET ROLL HOLDER 1

| | | |
|------------------|---|----------|
| Material | stainless steel | |
| Finish | brushed | polished |
| Item no. | N1909 | 01909 |
| Dimensions in mm | length 145 / height 111 / projection 40 | |

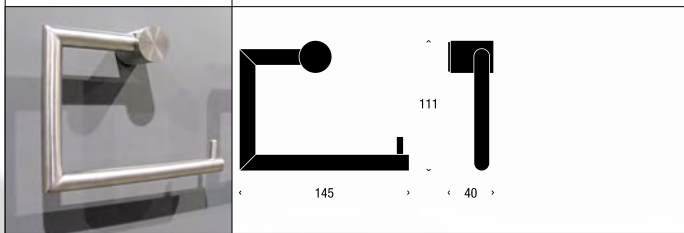

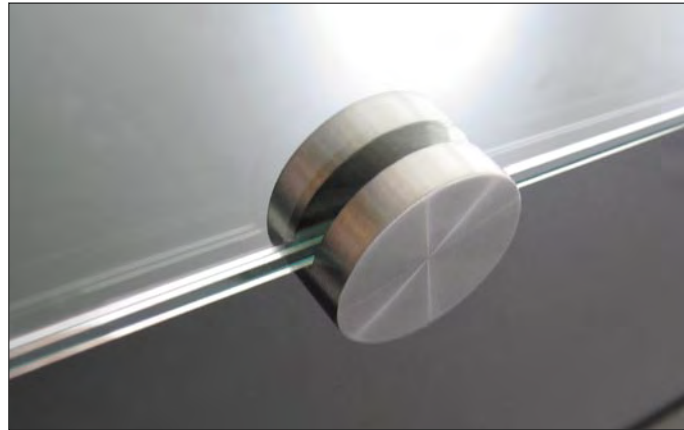

| MIRROR HOLDER 3 4 PCS. A SET | | |
|------------------------------|---|----------|
| Material | stainless steel | |
| Finish | brushed | polished |
| Item no. | N1932 | O1932 |
| Dimensions in mm | diameter ø28 / projection 33 / mirror thickness 3-6 | |
| | | |

| SHELF CLAMP 5 2 PCS. A SET | | |
|----------------------------|---|----------|
| Material | stainless steel | |
| Finish | brushed | polished |
| Item no. | N1933 | O1933 |
| Dimensions in mm | diameter ø28 / projection 40 / shelf thickness 6-10 | |
| | | |

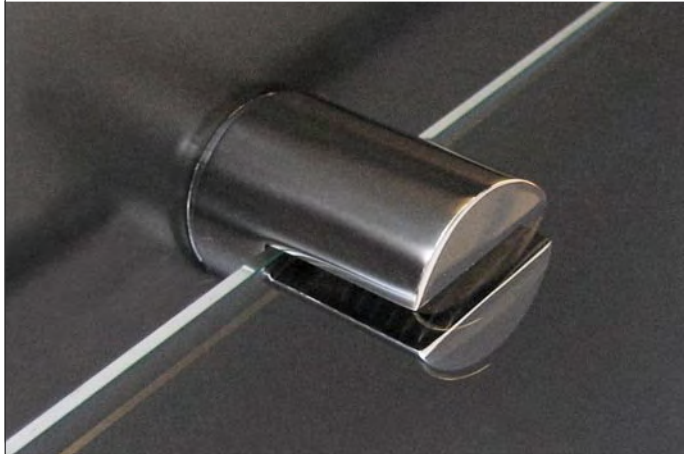

| SHOWER SHELF 2, CORNER | | |
|------------------------|----------------------------|----------|
| Material | stainless steel | |
| Finish | brushed | polished |
| Item no. | N1938 | O1938 |
| Dimensions in mm | width 200 / projection 120 | |
| | | |



| SHOWER SHELF 1 | | |
|------------------|----------------------------|----------|
| Material | stainless steel | |
| Finish | brushed | polished |
| Item no. | N1937 | O1937 |
| Dimensions in mm | width 200 / projection 120 | |
| | | |



SOAP DISPENSER 2, WALL

| | | |
|------------------|--|------------------|
| Material | stainless steel / plastic | |
| Finish | brushed / black | polished / black |
| Item no. | N1927 | O1927 |
| Dimensions in mm | diameter \varnothing 60 / height 166 / projection 87 | |

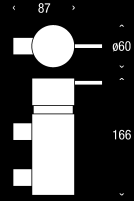

DISH HOLDER INCL. PORCELAIN DISH

| | | |
|------------------|-------------------------------|----------|
| Material | stainless steel | |
| Finish | brushed | polished |
| Item no. | N1915 | O1915 |
| Dimensions in mm | diameter ø90 / projection 145 | |

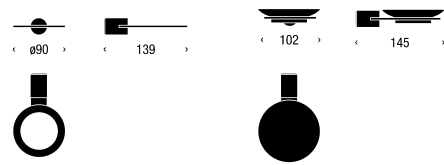

CUP HOLDER INCL. PORCELAIN CUP WITH LID

| | | |
|------------------|--|----------|
| Material | stainless steel | |
| Finish | brushed | polished |
| Item no. | N1925 | O1925 |
| Dimensions in mm | diameter ø90 / height 123 / projection 139 | |

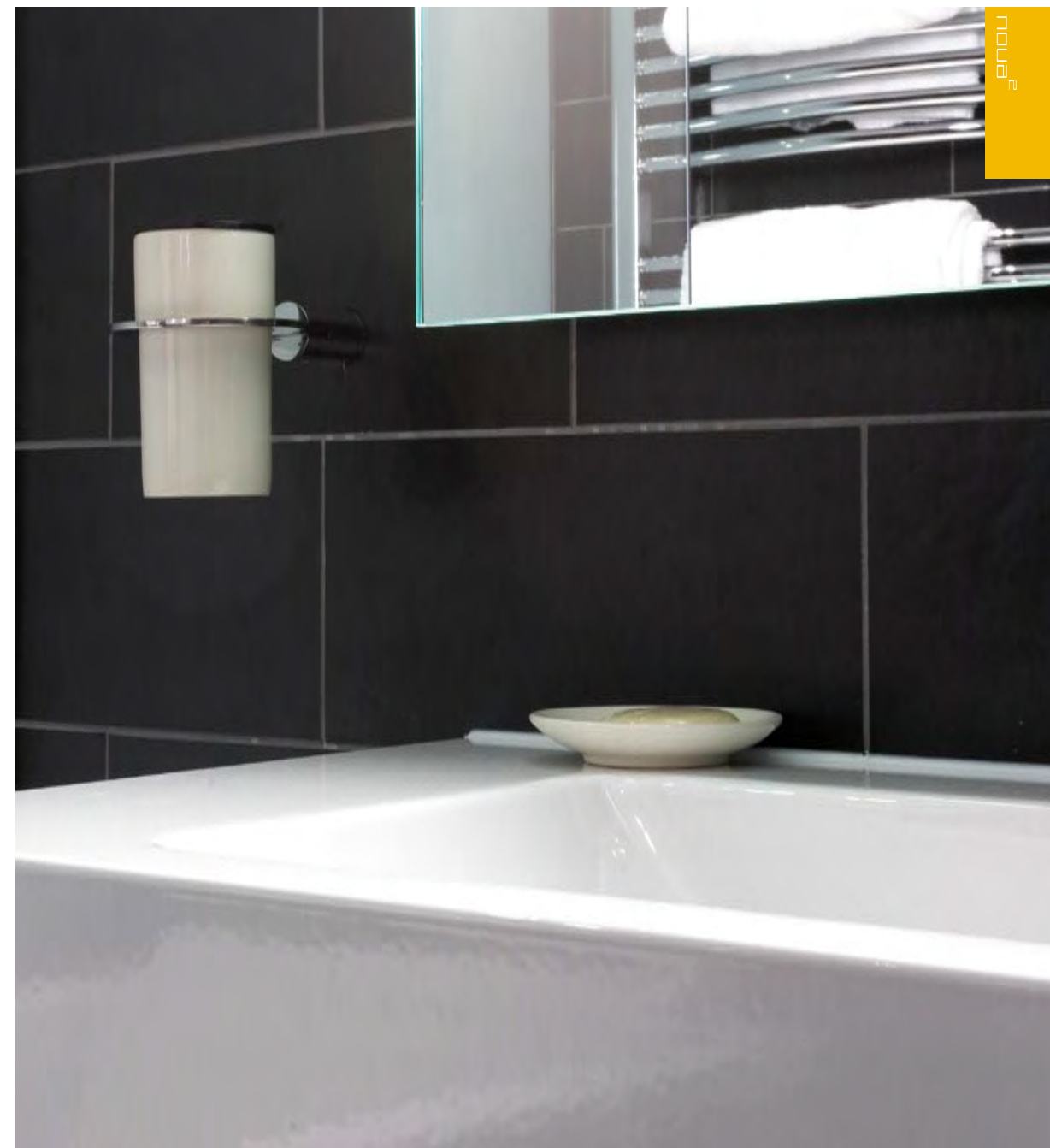
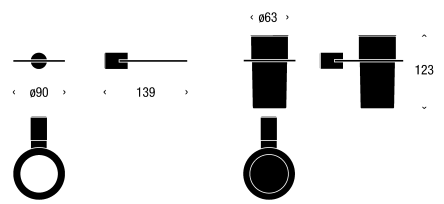



HOOK 6 2 PCS. A SET

| | | |
|------------------|---|-----------------|
| Material | brass | |
| Finish | brushed stainless | polished chrome |
| Item no. | N1901-1 | O1901-1 |
| Dimensions in mm | diameter \varnothing 16 / projection 27 | |

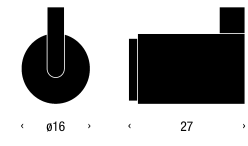

HOOK 6 L 2 PCS. A SET

| | | |
|------------------|---|-----------------|
| Material | brass | |
| Finish | brushed stainless | polished chrome |
| Item no. | N1901-2 | O1901-2 |
| Dimensions in mm | diameter \varnothing 25 / projection 50 | |

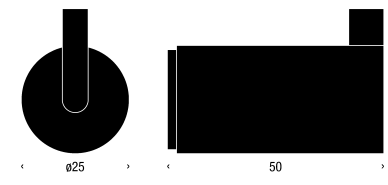



| HOOK 6 L X 2 | | | HOOK 6 L X 4 | | |
|------------------|----------------------------|-----------------|------------------|----------------------------|-----------------|
| Material | brass | | Material | brass | |
| Finish | brushed stainless | polished chrome | Finish | brushed stainless | polished chrome |
| Item no. | N1902-1 | O1902-1 | Item no. | N1902-2 | O1902-2 |
| Dimensions in mm | length 222 / projection 52 | | Dimensions in mm | length 406 / projection 52 | |
| | | | | | |

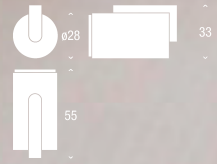

DOOR STOP 1

| | | |
|------------------|---|-------------------------|
| Material | brass / rubber | |
| Finish | brushed stainless / black | polished chrome / black |
| Item no. | N1931 | 01931 |
| Dimensions in mm | diameter \varnothing 28 / projection 55 | |

DOOR STOP 2

| | | |
|------------------|---|-------------------------|
| Material | brass / rubber | |
| Finish | brushed stainless / black | polished chrome / black |
| Item no. | N1931-1 | 01931-1 |
| Dimensions in mm | diameter \varnothing 28 / projection 75 | |

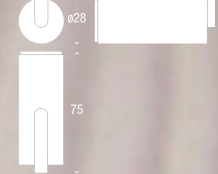

UNU » Hanger 4 » U3013 » page 56



| HALL STAND 4, FLOOR SWIVEL | | |
|----------------------------|-----------------------------|----------|
| Material | stainless steel | |
| Finish | brushed | polished |
| Item no. | N1935 | O1935 |
| Dimensions in mm | diameter ø300 / height 1900 | |
| | | |

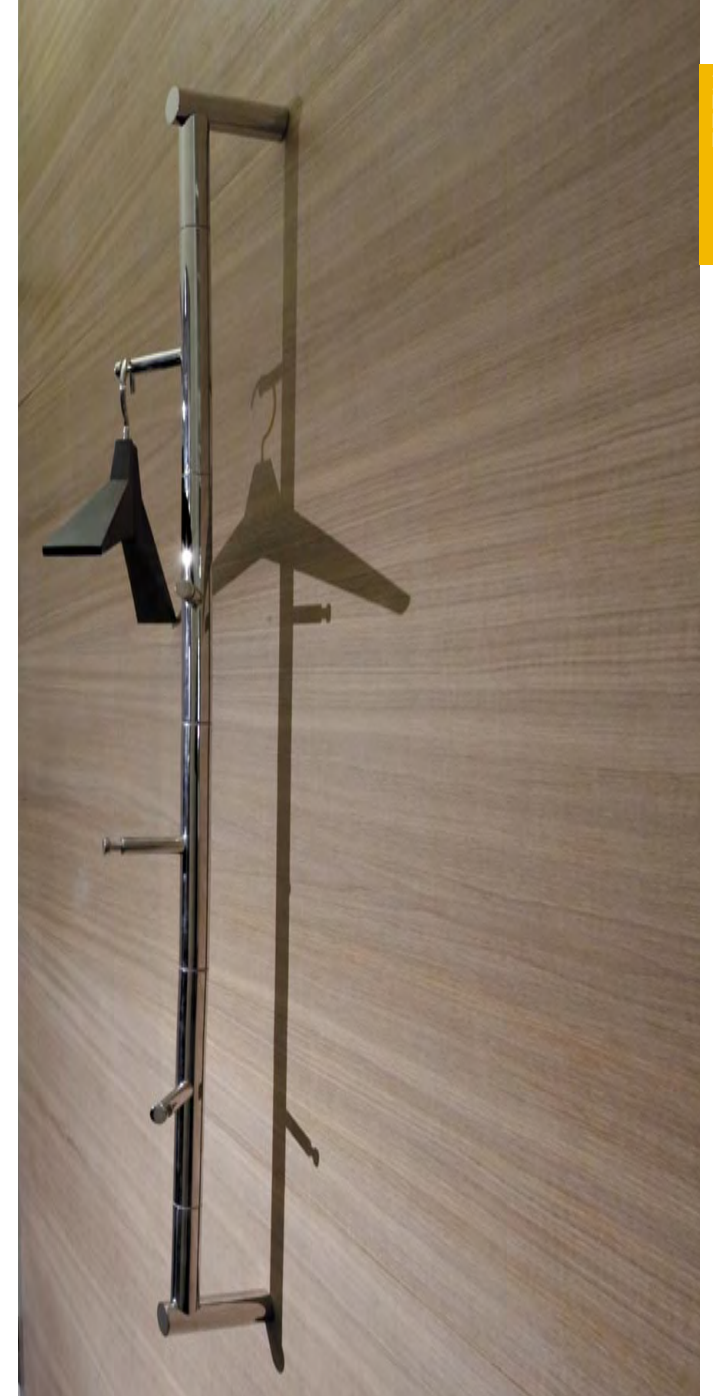

| HALL STAND 3, WALL SWIVEL | | |
|---------------------------|---------------------------|----------|
| Material | stainless steel | |
| Finish | brushed | polished |
| Item no. | N1904 | O1904 |
| Dimensions in mm | projection 100 / c-c 1000 | |
| | | |



NOVA2 » Hook For Bar 3 » N1907 » page 18

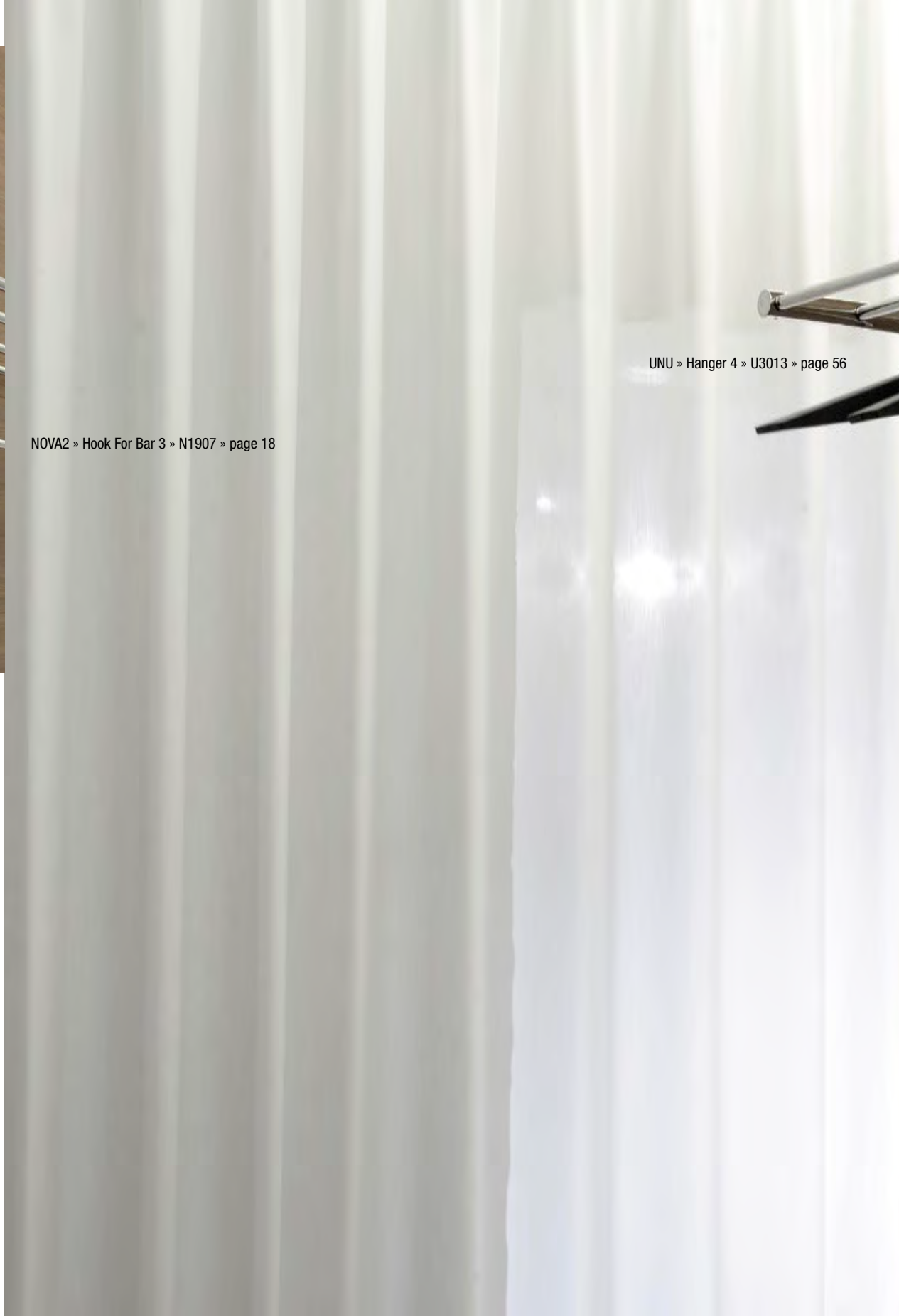

UNU » Hanger 4 » U3013 » page 56



WARDROBE SHELF 1

| | | |
|------------------|---------------------------------------|----------|
| Material | stainless steel | |
| Finish | brushed | polished |
| Item no. | N1936 | O1936 |
| Dimensions in mm | height 147 / projection 300 / c-c 600 | |





NOVA2 railing and hooks used as wardrobe with UNU hanger

NOVA2 » Kitchen Rail 2 » N1917-1 » page 11

NOVA2 » Hook For Bar 3 » N1907 » page 18

UNU » Hanger 4 » U3013 » page 56



UNU

Small finished furnishing products for wardrobes.

Small finished furnishing products for hallways.

Small finished furnishing products for living rooms.

The characteristic edging profile of the UNU series provides a slender look. The edging profile is also used constructively for e.g. placing of the mirror, so that a well-defined and complete impression is achieved.

Design: Bønnelycke mdd

Mirror With Mounting » U3009 » page 58

Shelf » U3001 » page 58

Hanger 4 » U3013 » page 56

Wardrobe Wall / Coat Rack » U3003 » page 54



| FINISHES | | | |
|--|---|---|---|
| Walnut | Black | White | Red |
|  |  |  |  |

| WARDROBE WALL / COAT RACK | | | | |
|---|--|------------------|------------------|----------------|
| Material | mdf / zinc | | | |
| Finish | walnut / brushed | black / polished | white / polished | red / polished |
| Item no. | U3003 | U3003-B | U3003-W | U3003-R |
| Dimensions in mm | length 600 / height 145 / projection 300 | | | |
|  | | | | |

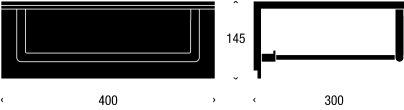

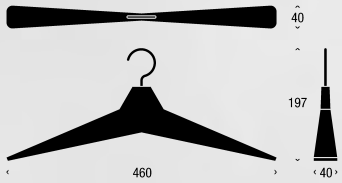

| WARDROBE WALL / COAT RACK | | | | |
|---|--|------------------|------------------|----------------|
| Material | mdf / zinc | | | |
| Finish | walnut / brushed | black / polished | white / polished | red / polished |
| Item no. | U3010 | U3010-B | U3010-W | U3010-R |
| Dimensions in mm | length 400 / height 145 / projection 300 | | | |
|  | | | | |

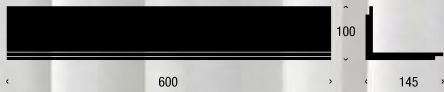
| HANGER 4 | |
|------------------|------------------------------------|
| Material | rubber / stainless steel |
| Finish | black / polished |
| Item no. | U3013 |
| Dimensions in mm | length 460 / height 197 / width 40 |

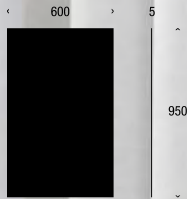

| SHELF | | | | |
|---|--|---------|---------|---------|
| Material | mdf | | | |
| Finish | walnut | black | white | red |
| Item no. | U3001 | U3001-B | U3001-W | U3001-R |
| Dimensions in mm | length 600 / height 100 / projection 145 | | | |
|  | | | | |

| MIRROR WITH MOUNTING | |
|---|---|
| Material | mirror |
| Finish | polished edge |
| Item no. | U3009 |
| Dimensions in mm | width 600 / height 950 / mirror thickness 5 |
|  | |

| FINISHES | | | |
|--|---|---|---|
| Walnut | Black | White | Red |
|  |  |  |  |





| FINISHES | | | |
|---|---|---|---|
| Walnut | Black | White | Red |
|  |  |  |  |

| WARDROBE WALL RACK | | | | |
|---|--|------------------|------------------|----------------|
| Material | mdf / zinc | | | |
| Finish | walnut / brushed | black / polished | white / polished | red / polished |
| Item no. | U3002 | U3002-B | U3002-W | U3002-R |
| Dimensions in mm | length 600 / height 100 / projection 145 | | | |
|  | | | | |

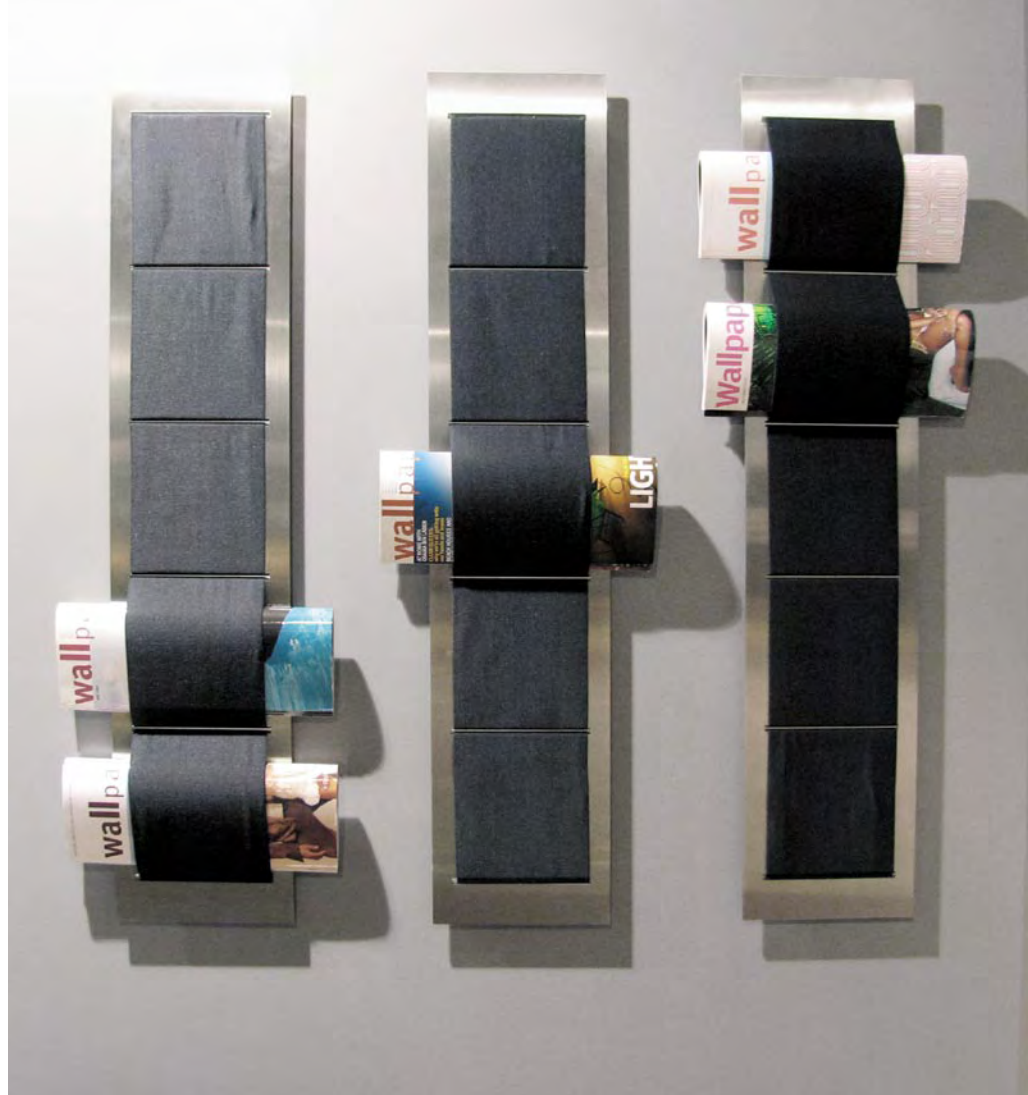

MAGAZINE HOLDER, WALL

| | |
|------------------|---------------------------|
| Material | stainless steel / elastic |
| Finish | brushed / black |
| Item no. | U3008 |
| Dimensions in mm | width 200 / height 950 |

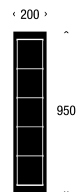

quadra®

Handles for furniture, bath furniture and kitchens.

Kitchen accessories.

Bathroom accessories.

Wardrobe accessories.

The proportional dimensions 8:5:3 define the QUADRA series as architectural building elements, which can be combined into various constructions.

When combined, the clear-cut and stylistically consistent details form a characteristic and well-defined system.

Design: Bønnelycke mdd

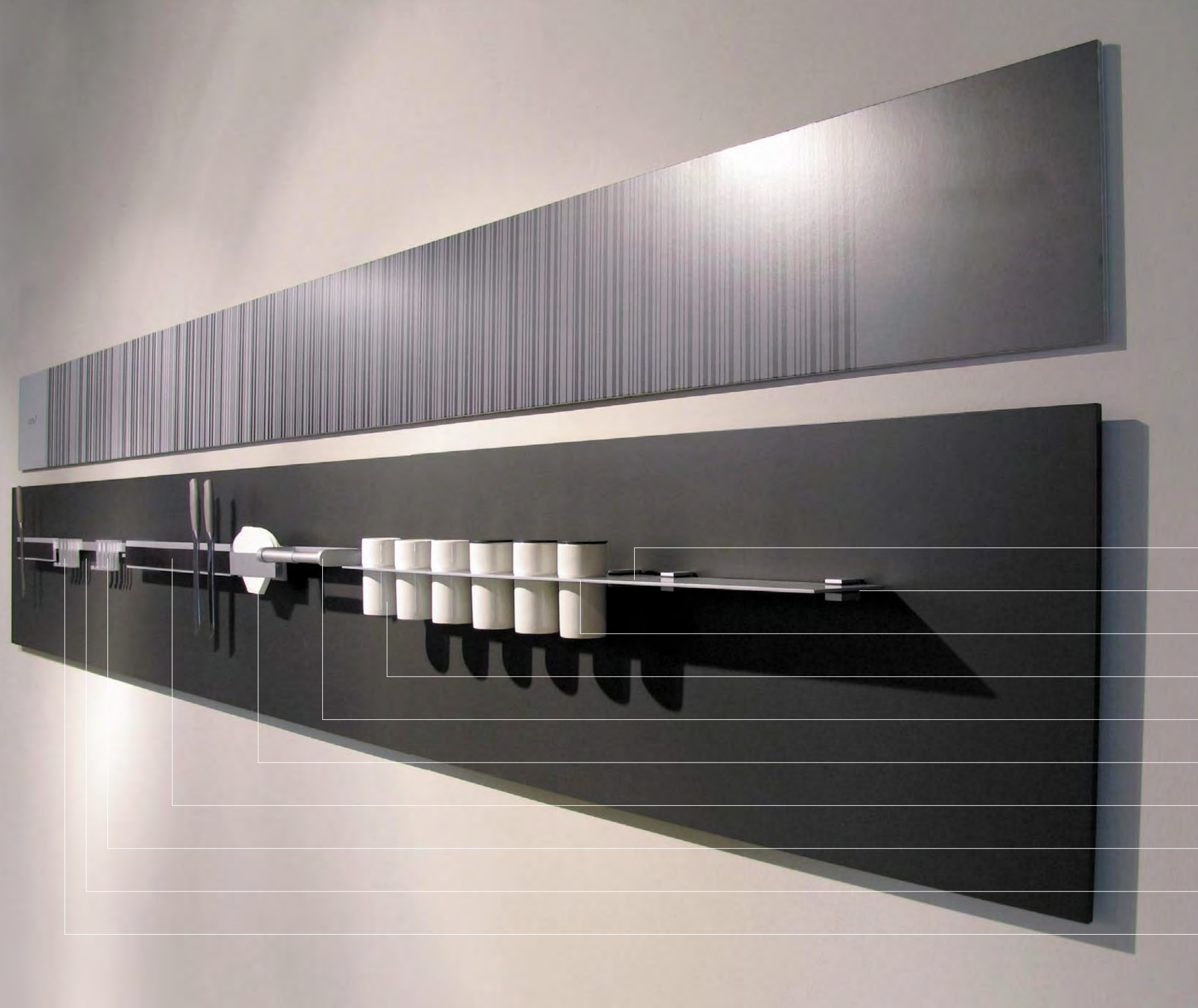

Shelf 5 360mm » Q3033.360.45 » page 70

Shelf Clamp 3 » Q3003.036.45 » page 67

Shelf 4 600mm » Q3032.600.45 » page 68

Cup With Lid » Q3040.063.45 » page 72

Kitchen Roll Holder 5 » Q3041.276.45 » page 81

Coffee Filter Holder 2 » Q3020.200.45 » page 80

Magnet Bar 2 » Q3036.600.45 » page 79

Hook 9 » Q3038.004.45 » page 76

Rail » Q3037.600.45 » page 75

Hook 10 » Q3038.016.45 » page 77



| SHELF CLAMP 3 2 PCS. A SET | | | |
|----------------------------|--|-------------------|-----------------|
| Material | aluminium | zinc | zinc |
| Finish | natural anodized | brushed stainless | polished chrome |
| Item no. | Q3003.036.45 | Q3003.036.10 | Q3003.036.25 |
| Dimensions in mm | length 22,5 / projection 36 / shelf thickness 4-10 | | |

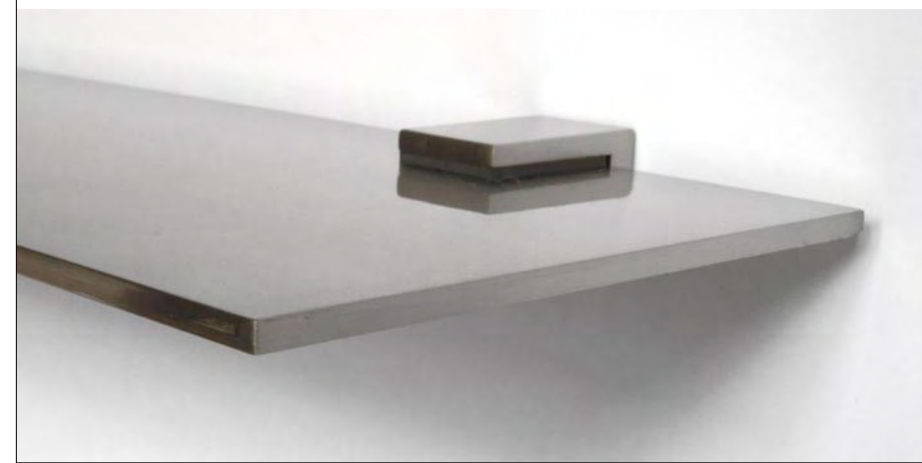
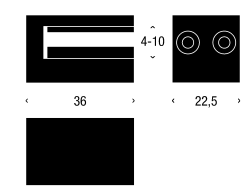

| SHELF CLAMP 4 WITH BACK PLATE / 2 PCS. A SET | | | |
|--|--|-------------------|-----------------|
| Material | aluminium | zinc | zinc |
| Finish | natural anodized | brushed stainless | polished chrome |
| Item no. | Q3004.037.45 | Q3004.037.10 | Q3004.037.25 |
| Dimensions in mm | length 22,5 / projection 37 / shelf thickness 4-10 | | |

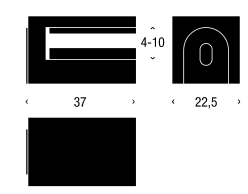

SHELF 4 90MM WITH CLAMP

| | | | |
|------------------|---|-------------------|-----------------|
| Material | aluminium | zinc / brass | zinc / brass |
| Finish | natural anodized | brushed stainless | polished chrome |
| Item no. | Q3032.090.45 | Q3032.090.10 | Q3032.090.25 |
| Dimensions in mm | width 90 / projection 120 / thickness 4 | | |

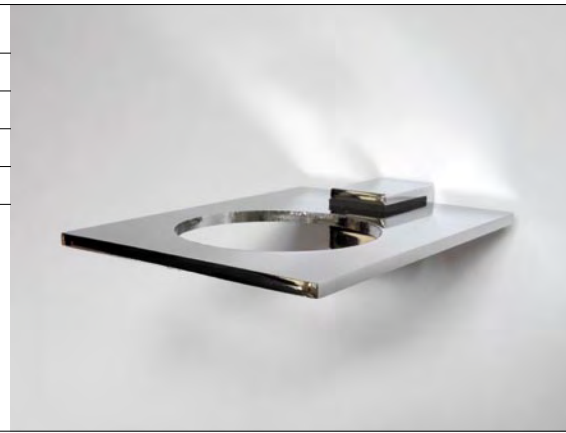
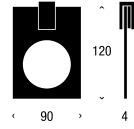

SHELF 6 120MM WITH CLAMP

| | |
|------------------|--|
| Material | aluminium |
| Finish | natural anodized |
| Item no. | Q3034.120.45 |
| Dimensions in mm | width 120 / projection 165 / thickness 4 |

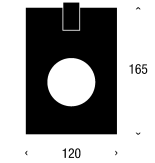

SHELF 4 360MM WITH CLAMPS

| | | | |
|------------------|--|-------------------|-----------------|
| Material | aluminium | zinc / brass | zinc / brass |
| Finish | natural anodized | brushed stainless | polished chrome |
| Item no. | Q3032.360.45 | Q3032.360.10 | Q3032.360.25 |
| Dimensions in mm | width 360 / projection 120 / thickness 4 | | |

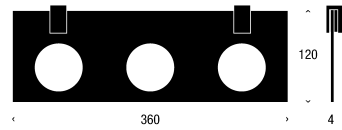

SHELF 6 360MM WITH CLAMPS

| | |
|------------------|--|
| Material | aluminium |
| Finish | natural anodized |
| Item no. | Q3034.360.45 |
| Dimensions in mm | width 360 / projection 165 / thickness 4 |

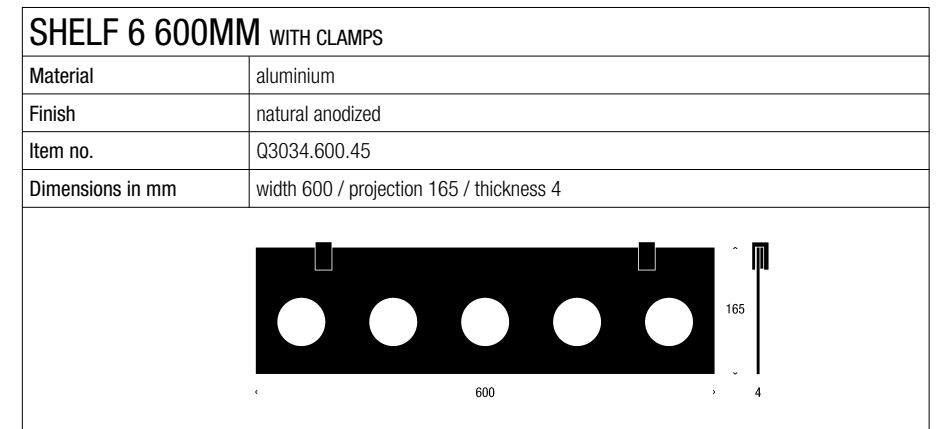
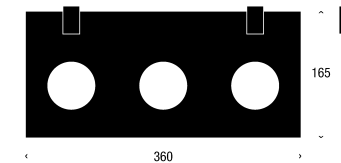

SHELF 4 600MM WITH CLAMPS

| | |
|------------------|--|
| Material | aluminium |
| Finish | natural anodized |
| Item no. | Q3032.600.45 |
| Dimensions in mm | width 600 / projection 120 / thickness 4 |

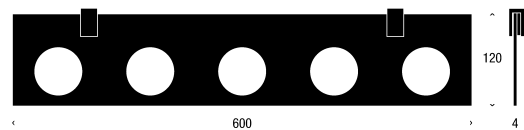

SHELF 6 600MM WITH CLAMPS

| | |
|------------------|--|
| Material | aluminium |
| Finish | natural anodized |
| Item no. | Q3034.600.45 |
| Dimensions in mm | width 600 / projection 165 / thickness 4 |

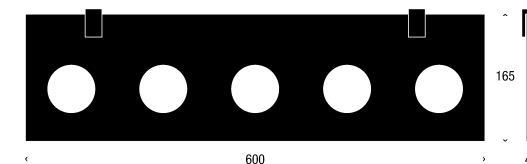

| SHELF 5 90MM WITH CLAMP | | | |
|-------------------------|---|-------------------|-----------------|
| Material | aluminium | zinc / brass | zinc / brass |
| Finish | natural anodized | brushed stainless | polished chrome |
| Item no. | Q3033.090.45 | Q3033.090.10 | Q3033.090.25 |
| Dimensions in mm | width 90 / projection 120 / thickness 4 | | |
| | | | |

| SHELF 7 120MM WITH CLAMP | |
|--------------------------|--|
| Material | aluminium |
| Finish | natural anodized |
| Item no. | Q3035.120.45 |
| Dimensions in mm | width 120 / projection 165 / thickness 4 |
| | |

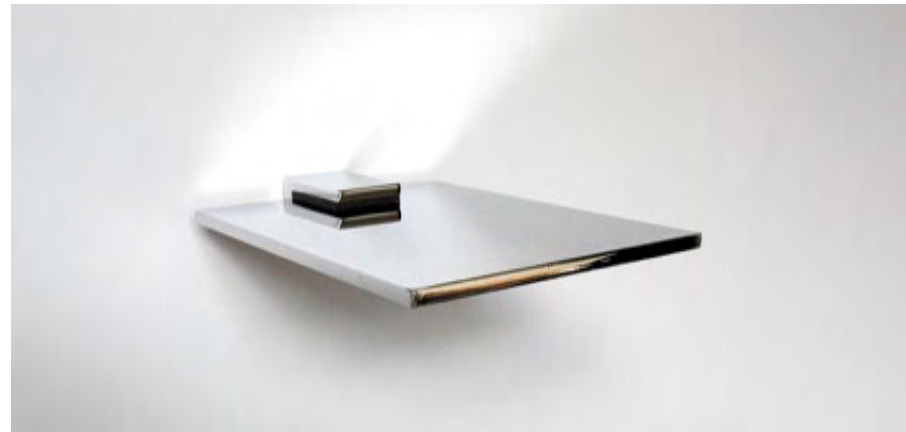

| SHELF 7 360MM WITH CLAMPS | |
|---------------------------|--|
| Material | aluminium |
| Finish | natural anodized |
| Item no. | Q3035.360.45 |
| Dimensions in mm | width 360 / projection 165 / thickness 4 |
| | |

| SHELF 5 360MM WITH CLAMPS | | | |
|---------------------------|--|-------------------|-----------------|
| Material | aluminium | zinc / brass | zinc / brass |
| Finish | natural anodized | brushed stainless | polished chrome |
| Item no. | Q3033.360.45 | Q3033.360.10 | Q3033.360.25 |
| Dimensions in mm | width 360 / projection 120 / thickness 4 | | |
| | | | |

| SHELF 7 600MM WITH CLAMPS | |
|---------------------------|--|
| Material | aluminium |
| Finish | natural anodized |
| Item no. | Q3035.600.45 |
| Dimensions in mm | width 600 / projection 165 / thickness 4 |
| | |

| SHELF 5 600MM WITH CLAMPS | | | |
|---------------------------|--|-------------------|-----------------|
| Material | aluminium | zinc / brass | zinc / brass |
| Finish | natural anodized | brushed stainless | polished chrome |
| Item no. | Q3033.600.45 | Q3033.600.10 | Q3033.600.25 |
| Dimensions in mm | width 600 / projection 120 / thickness 4 | | |
| | | | |

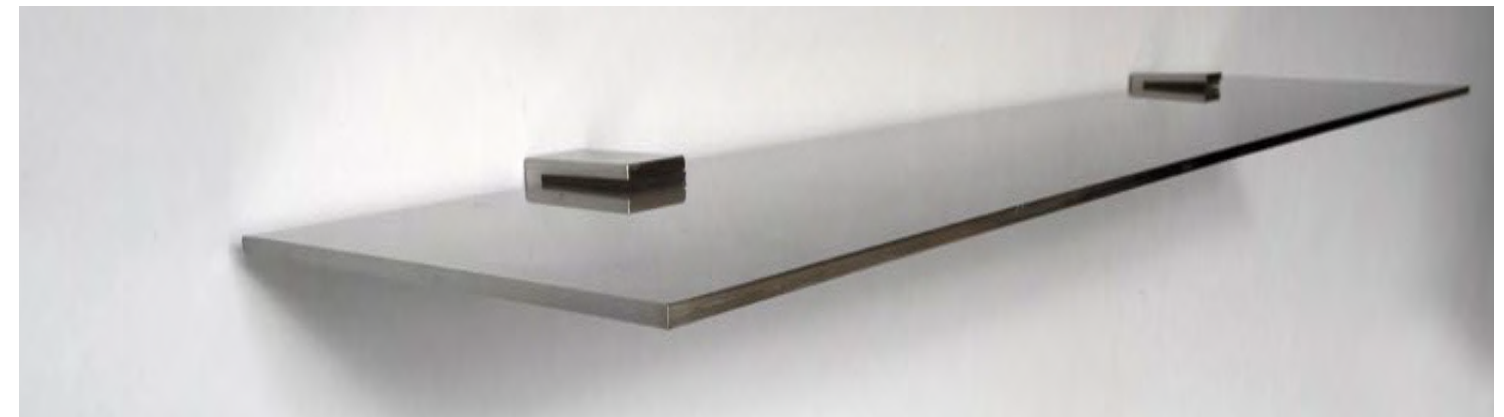

| SOAP DISH | |
|------------------|---------------------------|
| Material | porcelain |
| Finish | cream white |
| Item no. | Q3039.102.45 |
| Dimensions in mm | diameter ø102 / height 23 |

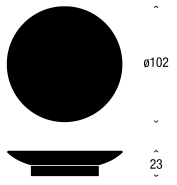

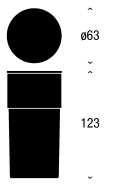

| CUP WITH LID | |
|------------------|---------------------------|
| Material | porcelain / plastic |
| Finish | cream white / black |
| Item no. | Q3040.063.45 |
| Dimensions in mm | diameter ø63 / height 123 |



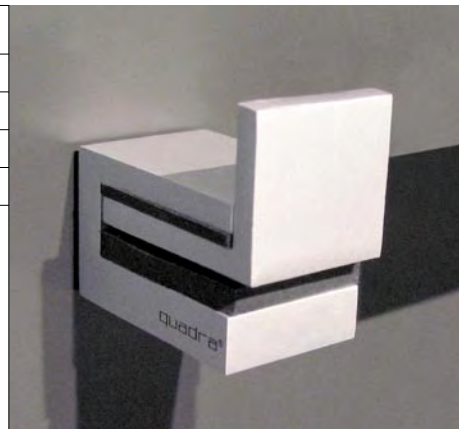
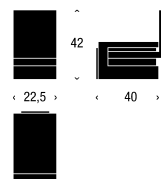

MINI RAIL 2 PCS. A SET

| | |
|------------------|---|
| Material | aluminium |
| Finish | natural anodized |
| Item no. | Q3037.604.45 |
| Dimensions in mm | length 22,5 / height 42 / projection 40 |



RAIL

| | |
|------------------|--|
| Material | aluminium |
| Finish | natural anodized |
| Item no. | Q3037.600.45 |
| Dimensions in mm | length 600 / height 42 / projection 40 |



| | |
|----------------------------|---------------------------------------|
| HOOK 9 4 PCS. A SET | |
| Material | aluminium |
| Finish | natural anodized |
| Item no. | Q3038.004.45 |
| Dimensions in mm | width 4 / height 75 / projection 31,5 |
| | |



| | |
|-----------------------------|--|
| HOOK 10 4 PCS. A SET | |
| Material | aluminium |
| Finish | natural anodized |
| Item no. | Q3038.016.45 |
| Dimensions in mm | width 16 / height 75 / projection 31,5 |
| | |



| MAGNET BAR 1 WITH MINI RAIL | | MAGNET BAR 2 WITH MINI RAIL | |
|-----------------------------|--|-----------------------------|--|
| Material | aluminium / magnetic rubber | Material | aluminium / magnetic rubber |
| Finish | natural anodized | Finish | natural anodized |
| Item no. | Q3036.360.45 | Item no. | Q3036.600.45 |
| Dimensions in mm | length 360 / height 65 / projection 16 | Dimensions in mm | length 600 / height 65 / projection 16 |
| | | | |

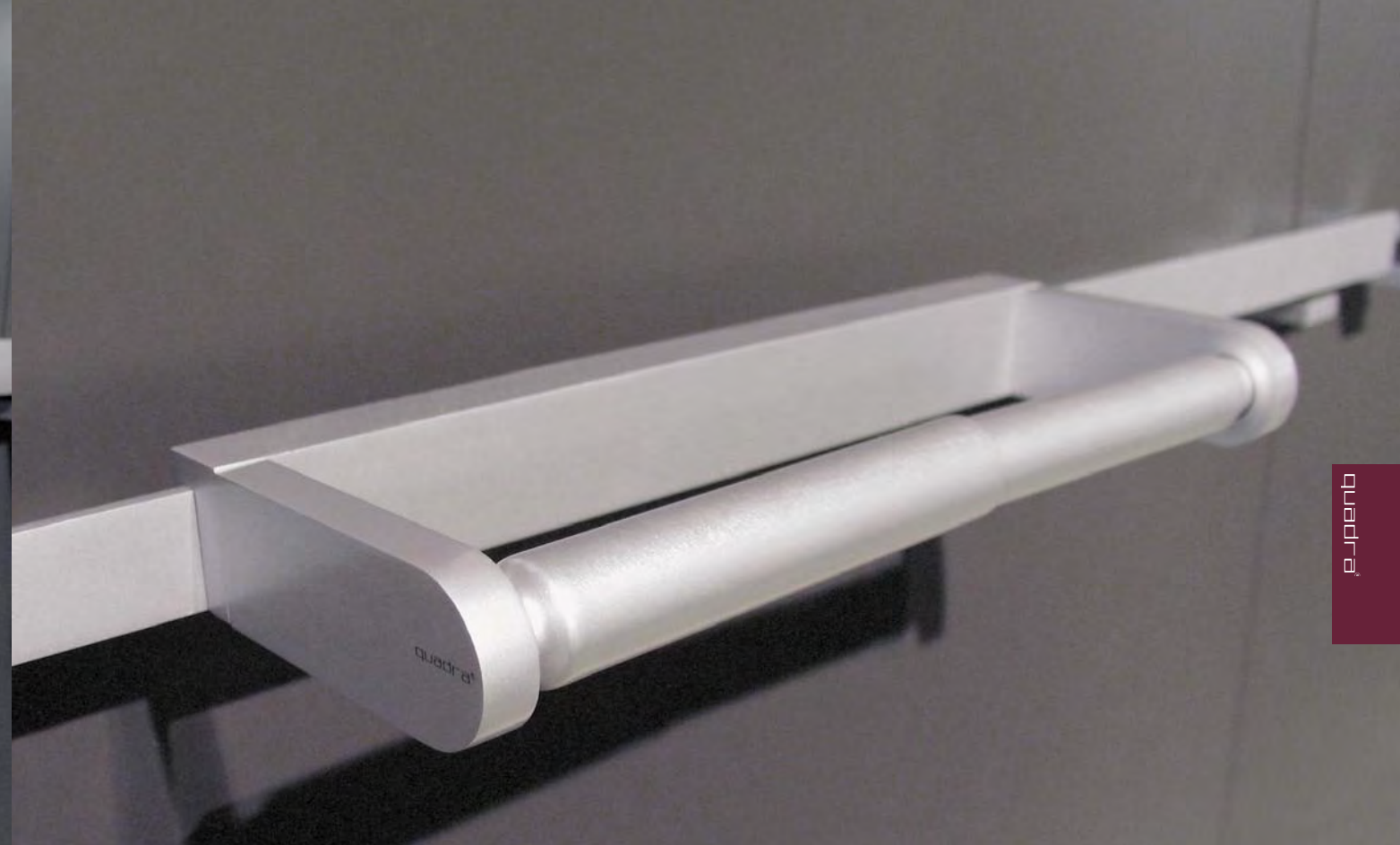
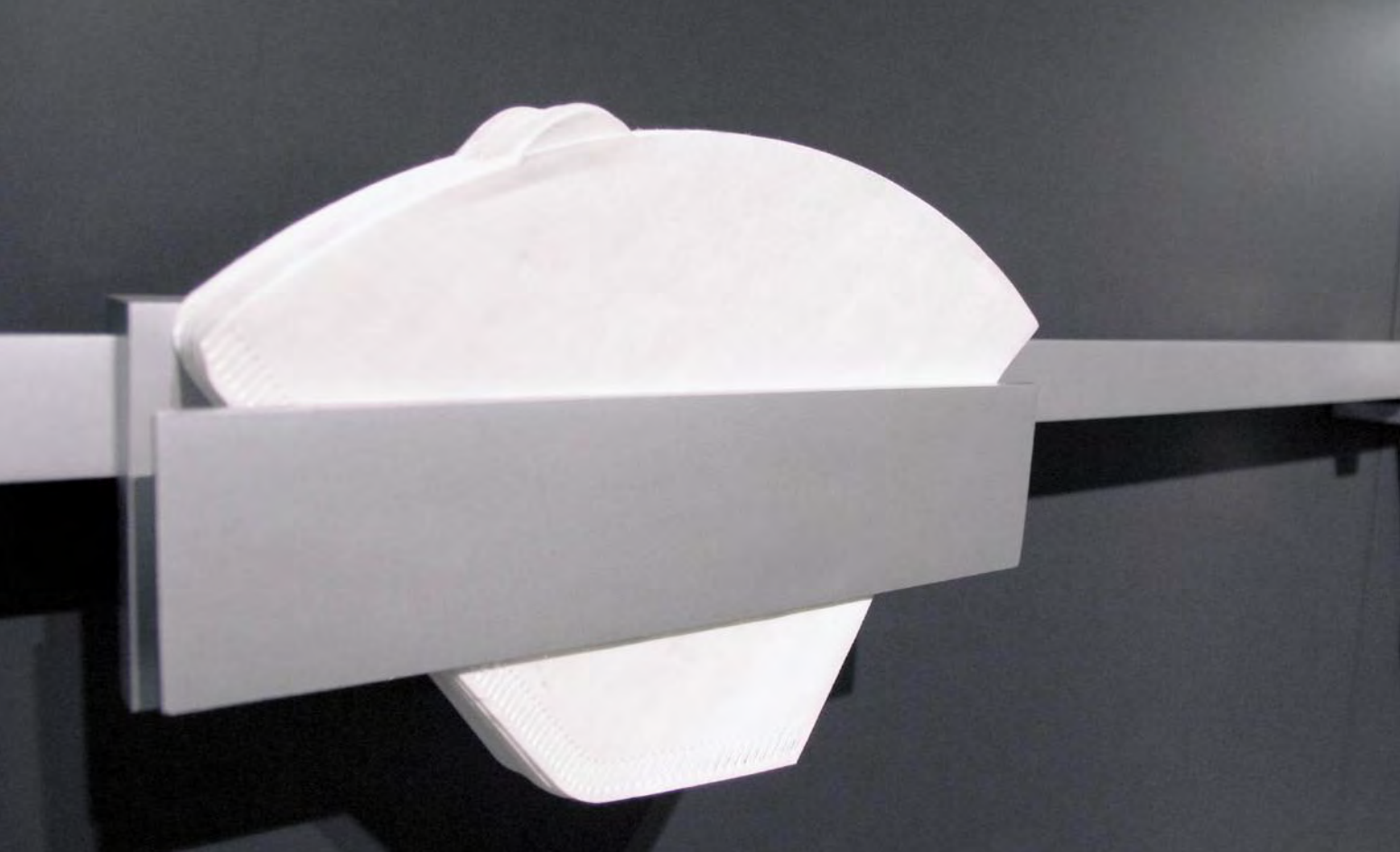

| COFFEE FILTER HOLDER 2 | |
|------------------------|--|
| Material | aluminium |
| Finish | natural anodized |
| Item no. | Q3020.200.45 |
| Dimensions in mm | length 200 / height 65 / projection 34 |

| KITCHEN ROLL HOLDER 5 | |
|-----------------------|--|
| Material | aluminium |
| Finish | natural anodized |
| Item no. | Q3041.276.45 |
| Dimensions in mm | length 276 / height 28,5 / projection 90 |



KITCHEN ROLL HOLDER 4

| | |
|------------------|-------------------------------------|
| Material | aluminium |
| Finish | natural anodized |
| Item no. | Q3024.281.45 |
| Dimensions in mm | length 120 / width 120 / height 281 |

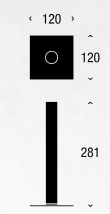



KITCHEN ROLL HOLDER 3

| | |
|------------------|---|
| Material | aluminium |
| Finish | natural anodized |
| Item no. | Q3018.256.45 |
| Dimensions in mm | length 256 / height 100 / projection 36 |

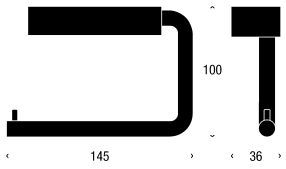

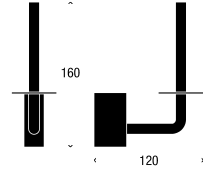

| TOILET ROLL HOLDER 3 | | | |
|---|---|-------------------|-----------------|
| Material | aluminium | zinc / brass | zinc / brass |
| Finish | natural anodized | brushed stainless | polished chrome |
| Item no. | Q3014.145.45 | Q3014.145.10 | Q3014.145.25 |
| Dimensions in mm | length 145 / height 100 / projection 36 | | |
|  | | | |



| TOILET ROLL HOLDER 4 | | | |
|---|-----------------------------|-------------------|-----------------|
| Material | aluminium | zinc / brass | zinc / brass |
| Finish | natural anodized | brushed stainless | polished chrome |
| Item no. | Q3015.160.45 | Q3015.160.10 | Q3015.160.25 |
| Dimensions in mm | height 160 / projection 120 | | |
|  | | | |

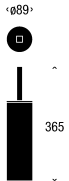

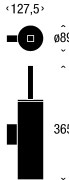
| TOILET BRUSH 3, FLOOR REPLACEABLE BRUSH | | | |
|---|---------------------------|-----------------|-----------------|
| Material | aluminium | stainless steel | stainless steel |
| Finish | natural anodized | brushed | polished |
| Item no. | Q3022.365.45 | Q3022.365.10 | Q3022.365.25 |
| Dimensions in mm | diameter ø89 / height 365 | | |
|  | | | |

| TOILET BRUSH 4, WALL REPLACEABLE BRUSH | | | |
|---|--|-----------------|-----------------|
| Material | aluminium | stainless steel | stainless steel |
| Finish | natural anodized | brushed | polished |
| Item no. | Q3023.365.45 | Q3023.365.10 | Q3023.365.25 |
| Dimensions in mm | diameter ø89 / height 365 / projection 127,5 | | |
|  | | | |



TOWEL RING 2

| | | | |
|------------------|--|-------------------|-----------------|
| Material | aluminium | zinc / brass | zinc / brass |
| Finish | natural anodized | brushed stainless | polished chrome |
| Item no. | Q3027.212.45 | Q3027.212.10 | Q3027.212.25 |
| Dimensions in mm | diameter \varnothing 212 / projection 65 | | |

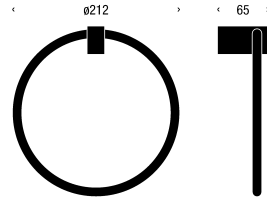

SHELF 8

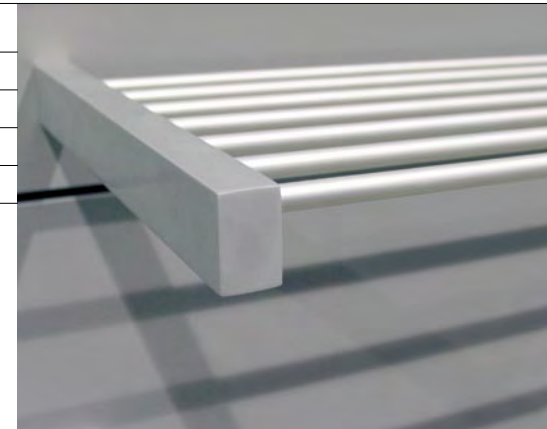
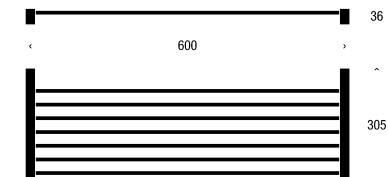

| | | | |
|------------------|--------------------------------------|-------------------|-----------------|
| Material | aluminium | zinc / brass | zinc / brass |
| Finish | natural anodized | brushed stainless | polished chrome |
| Item no. | Q3042.600.45 | Q3042.600.10 | Q3042.600.25 |
| Dimensions in mm | height 36 / projection 305 / c-c 600 | | |



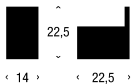
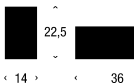

| TOWEL BAR 5 | | | |
|------------------|--|-------------------|-----------------|
| Material | aluminium | zinc / brass | zinc / brass |
| Finish | natural anodized | brushed stainless | polished chrome |
| Item no. | Q3016.600.45 | Q3016.600.10 | Q3016.600.25 |
| Dimensions in mm | bar diameter $\phi 12$ / projection 65 / c-c 600 | | |
| | | | |

| TOWEL BAR 6 | | | |
|------------------|---|-------------------|-----------------|
| Material | aluminium | zinc / brass | zinc / brass |
| Finish | natural anodized | brushed stainless | polished chrome |
| Item no. | Q3017.600.45 | Q3017.600.10 | Q3017.600.25 |
| Dimensions in mm | bar diameter $\phi 12$ / projection 105 / c-c 600 | | |
| | | | |

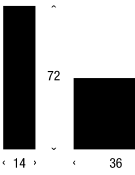

| HOOK 7 2 PCS. A SET | | HOOK 7 L 2 PCS. A SET | |
|---|--|---|--|
| Material | aluminium | Material | aluminium |
| Finish | natural anodized | Finish | natural anodized |
| Item no. | Q3011.022.45 | Item no. | Q3011.036.45 |
| Dimensions in mm | width 14 / height 22,5 / projection 22,5 | Dimensions in mm | width 14 / height 22,5 / projection 36 |
|  | |  | |
|  | |  | |

| HOOK 11 2 PCS. A SET | |
|--|--------------------------------------|
| Material | aluminium |
| Finish | natural anodized |
| Item no. | Q3013.036.45 |
| Dimensions in mm | width 14 / height 72 / projection 36 |
|  | |
|  | |



HOOK 8 2 PCS. A SET

| | | | |
|------------------|--|-------------------|-----------------|
| Material | aluminium | zinc / brass | zinc / brass |
| Finish | natural anodized | brushed stainless | polished chrome |
| Item no. | Q3012.022.45 | Q3012.022.10 | Q3012.022.25 |
| Dimensions in mm | width 14 / height 36 / projection 22,5 | | |

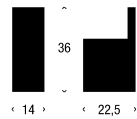

quebrã

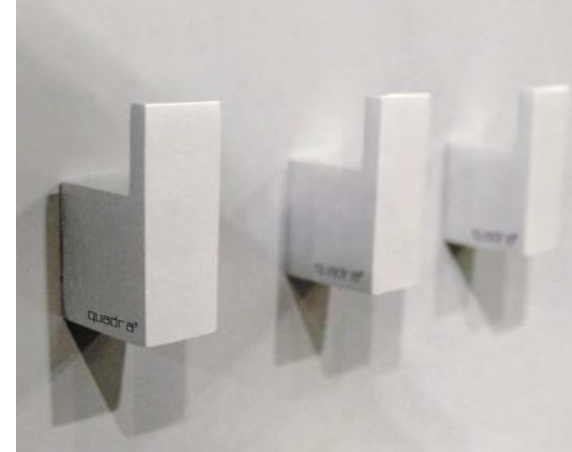

HOOK 8 L 2 PCS. A SET

| | | | |
|------------------|--|-------------------|-----------------|
| Material | aluminium | zinc / brass | zinc / brass |
| Finish | natural anodized | brushed stainless | polished chrome |
| Item no. | Q3012.036.45 | Q3012.036.10 | Q3012.036.25 |
| Dimensions in mm | width 22,5 / height 36 / projection 36 | | |

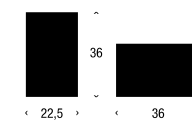



MIRROR HOLDER 4 4 PCS. A SET

| | | | |
|------------------|---|-------------------|-----------------|
| Material | aluminium | zinc | zinc |
| Finish | natural anodized | brushed stainless | polished chrome |
| Item no. | Q3021.014.45 | Q3021.014.10 | Q3021.014.25 |
| Dimensions in mm | length 14 / height 36 / projection 22,5 / mirror thickness 3-10 | | |

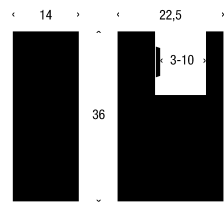

MIRROR HOLDER 5 4 PCS. A SET

| | | | |
|------------------|---|-------------------|-----------------|
| Material | aluminium | zinc | zinc |
| Finish | natural anodized | brushed stainless | polished chrome |
| Item no. | Q3021.022.45 | Q3021.022.10 | Q3021.022.25 |
| Dimensions in mm | length 22,5 / height 36 / projection 22,5 / mirror thickness 3-10 | | |

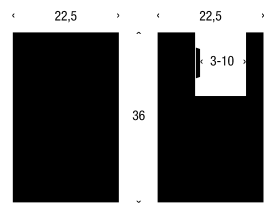

| SHELF BRACKET 3 2 PCS. A SET | | | |
|------------------------------|---|-------------------|-----------------|
| Material | aluminium | zinc | zinc |
| Finish | natural anodized | brushed stainless | polished chrome |
| Item no. | Q3005.120.45 | Q3005.120.10 | Q3005.120.25 |
| Dimensions in mm | width 14 / height 22,5 / projection 120 | | |
| | | | |

| SHELF BRACKET 4 2 PCS. A SET | | | |
|------------------------------|---|-------------------|-----------------|
| Material | aluminium | zinc | zinc |
| Finish | natural anodized | brushed stainless | polished chrome |
| Item no. | Q3005.200.45 | Q3005.200.10 | Q3005.200.25 |
| Dimensions in mm | width 14 / height 22,5 / projection 200 | | |
| | | | |



SHELF CLAMP 6 ADJUSTABLE

| | | | |
|------------------|---|-------------------|-----------------|
| Material | zinc | zinc | zinc |
| Finish | matt chrome | brushed stainless | polished chrome |
| Item no. | Q3046.080.05 | Q3046.080.10 | Q3046.080.25 |
| Dimensions in mm | width 24 / projection 80 / shelf thickness 6-30 | | |

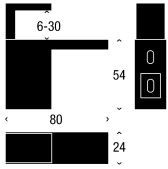
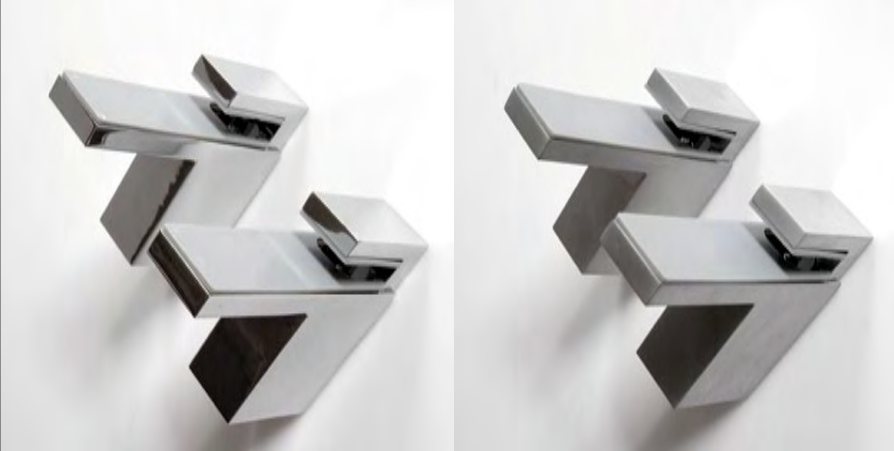



NOVA

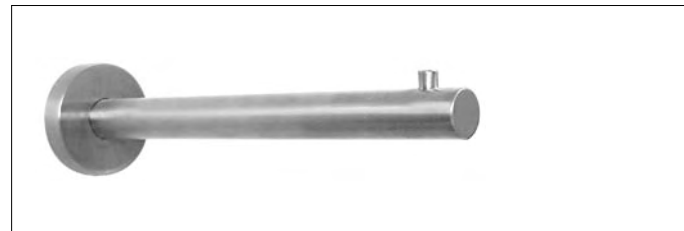

| MIRROR HOLDER 1 4 PCS. A SET | | |
|------------------------------|--|----------|
| Material | stainless steel | |
| Finish | brushed | polished |
| Item no. | N1120a | O1120a |
| Dimensions in mm | diameter \varnothing 25 / projection 22 / mirror thickness 3-6 | |
| | | |

| MIRROR HOLDER 2 4 PCS. A SET | | |
|------------------------------|--|----------|
| Material | stainless steel | |
| Finish | brushed | polished |
| Item no. | N1120b | O1120b |
| Dimensions in mm | diameter \varnothing 20 / projection 14 / mirror thickness 3-6 | |
| | | |



| SHELF CLAMP 1 2 PCS. A SET | | |
|----------------------------|--|----------|
| Material | stainless steel | |
| Finish | brushed | polished |
| Item no. | N1138 | O1138 |
| Dimensions in mm | diameter \varnothing 25 / projection 26 / glass thickness 6-10 | |
| | | |

| SHELF CLAMP 2 2 PCS. A SET | | |
|----------------------------|--|----------|
| Material | stainless steel | |
| Finish | brushed | polished |
| Item no. | N1139 | O1139 |
| Dimensions in mm | diameter \varnothing 35 / projection 45 / glass thickness 8-12 | |
| | | |

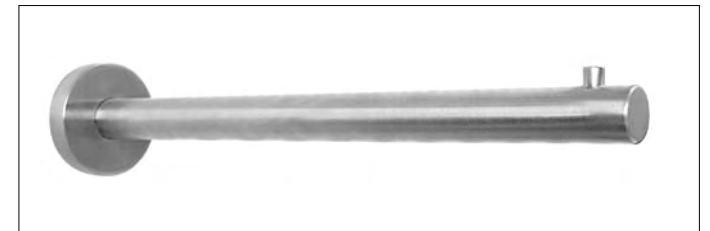

| SHELF BRACKET 1 | | |
|------------------|--|----------|
| Material | stainless steel | |
| Finish | brushed | polished |
| Item no. | N1115 | O1115 |
| Dimensions in mm | diameter \varnothing 16 / projection 167,5 | |
| | | |

| SHELF BRACKET 2 | | |
|------------------|--|----------|
| Material | stainless steel | |
| Finish | brushed | polished |
| Item no. | N1116 | O1116 |
| Dimensions in mm | diameter \varnothing 16 / projection 217,5 | |
| | | |



| | |
|------------------|-----------------------------|
| HOOK 1 | |
| Material | stainless steel |
| Finish | brushed |
| Item no. | N1122 |
| Dimensions in mm | diameter ø8 / projection 40 |
| | |

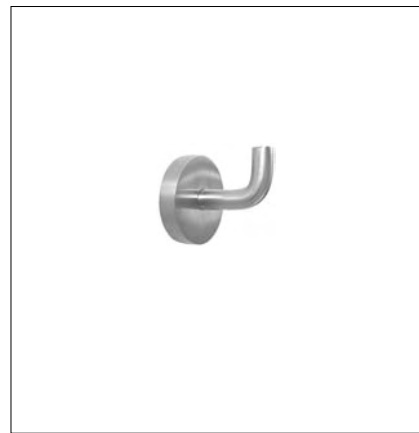

| | |
|------------------|--|
| HOOK 2 | |
| Material | stainless steel |
| Finish | brushed |
| Item no. | N1133 |
| Dimensions in mm | diameter ø8 / projection 89 / height 103 |
| | |



| | |
|-------------------|---------------------------------------|
| HOOK 2 X 3 | |
| Material | stainless steel |
| Finish | brushed |
| Item no. | N1131 |
| Dimensions in mm | diameter ø8 / projection 91 / c-c 300 |
| | |



| | | |
|-------------------|---------------------------------------|----------|
| HOOK 2 X 5 | | |
| Material | stainless steel | |
| Finish | brushed | polished |
| Item no. | N1132 | O1132 |
| Dimensions in mm | diameter ø8 / projection 91 / c-c 450 | |
| | | |

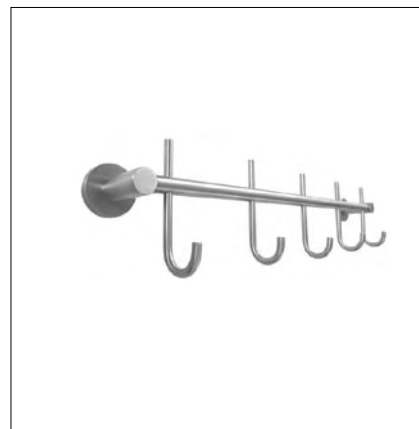

| | | | | | |
|------------------|------------------------------|----------|------------------|------------------------------|----------|
| HOOK 4 | | | HOOK 4 L | | |
| Material | stainless steel | | Material | stainless steel | |
| Finish | brushed | polished | Finish | brushed | polished |
| Item no. | N1127 | O1127 | Item no. | N1128 | O1128 |
| Dimensions in mm | diameter ø16 / projection 35 | | Dimensions in mm | diameter ø20 / projection 60 | |
| | | | | | |



HOOK 5

| | | |
|------------------|---|----------|
| Material | stainless steel | |
| Finish | brushed | polished |
| Item no. | N1124 | O1124 |
| Dimensions in mm | diameter \varnothing 25 / projection 30 | |

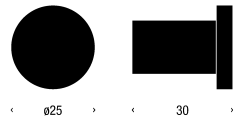

HOOK 5 X 2

| | | |
|------------------|--|----------|
| Material | stainless steel | |
| Finish | brushed | polished |
| Item no. | N1125 | O1125 |
| Dimensions in mm | diameter \varnothing 25 / length 222 / projection 31,5 | |

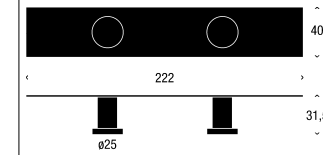

HOOK 5 X 4

| | | |
|------------------|--|----------|
| Material | stainless steel | |
| Finish | brushed | polished |
| Item no. | N1126 | O1126 |
| Dimensions in mm | diameter \varnothing 25 / length 406 / projection 31,5 | |

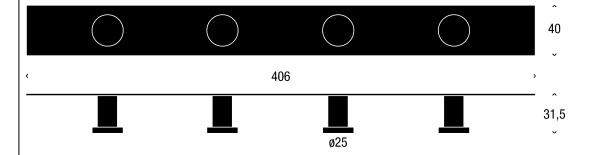

HOOK 5 X 5

| | | |
|------------------|-----------------|--|
| Material | stainless steel | |
| Finish | brushed | |
| Item no. | N1172a | |
| Dimensions in mm | c-c 380 | |

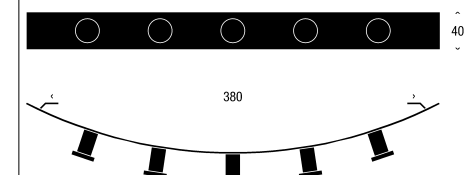



| TOWEL BAR 1 | | TOWEL BAR 2 | |
|------------------|---|------------------|---|
| Material | stainless steel | Material | stainless steel |
| Finish | brushed | Finish | brushed |
| Item no. | N1118 | Item no. | N1121 |
| Dimensions in mm | diameter \varnothing 16 / projection 53 / c-c 500 | Dimensions in mm | diameter \varnothing 16 / projection 45 / c-c 500 |
| | | | |

| CLOSET ROD | | | BAR RAILING / CLOSET ROD | |
|------------------|---|----------|--------------------------|---|
| Material | stainless steel | | Material | stainless steel |
| Finish | brushed | polished | Finish | brushed |
| Item no. | N1123 | O1123 | Item no. | N1930 |
| Dimensions in mm | diameter \varnothing 16 / length 1000 | | Dimensions in mm | diameter \varnothing 16 / length 1500 |
| | | | | |

SHELF 2

| | | |
|------------------|--------------------------|----------|
| Material | stainless steel | |
| Finish | brushed | polished |
| Item no. | N1149 | O1149 |
| Dimensions in mm | projection 300 / c-c 600 | |

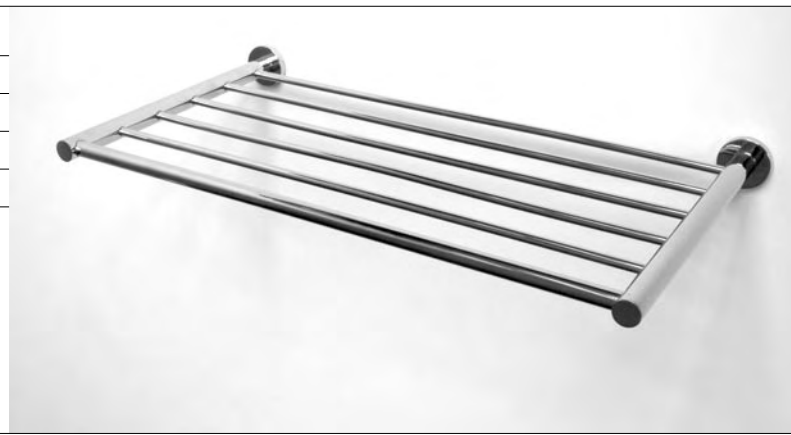
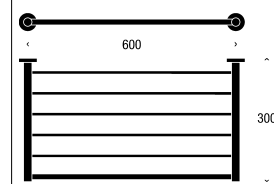

SHELF 1

| | | |
|------------------|----------------------------|--|
| Material | stainless steel | |
| Finish | brushed | |
| Item no. | N1179 | |
| Dimensions in mm | projection 200m / c-c 1000 | |

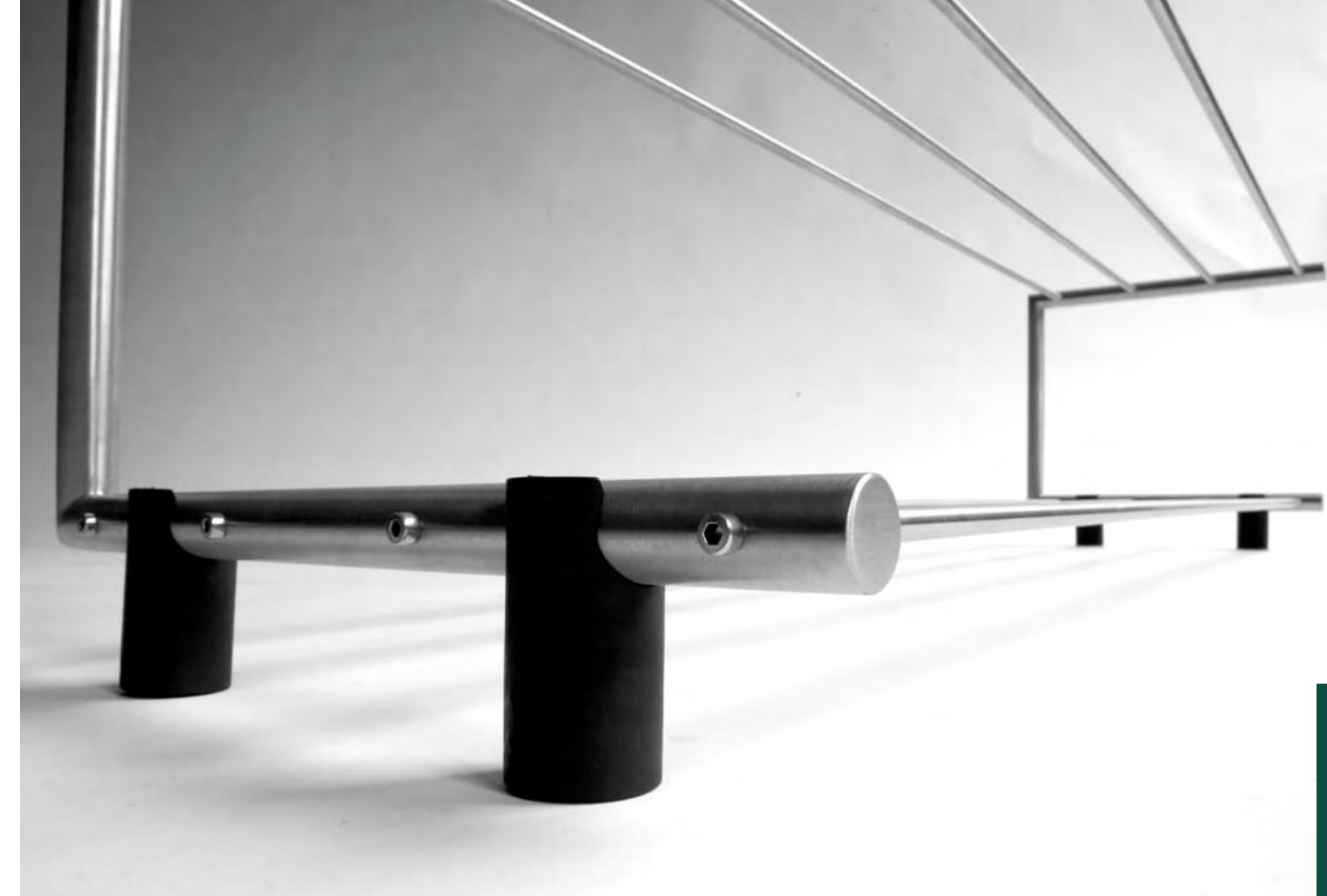
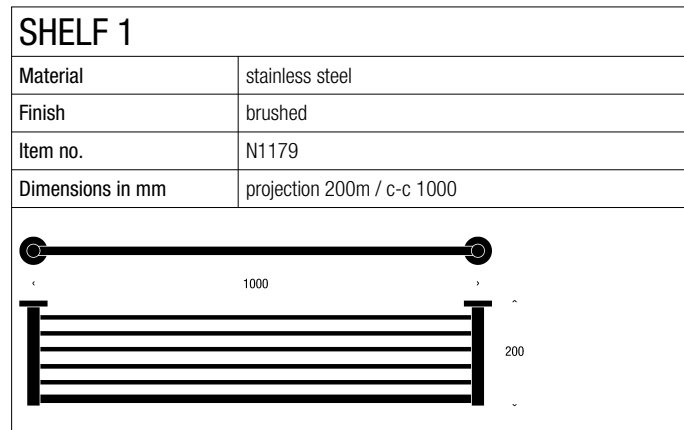
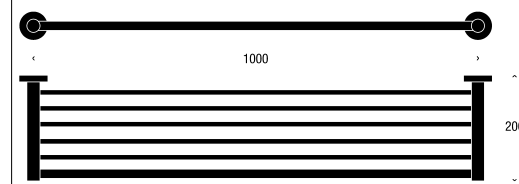

FEET FOR SHOE SHELF 4 PCS. A SET

| | |
|------------------|----------------------------|
| Material | rubber |
| Finish | black |
| Item no. | N1929-4 |
| Dimensions in mm | diameter Ø30 / height 57,5 |

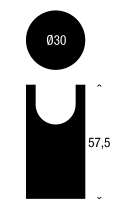

SHOE SHELF 1

| | |
|------------------|---------------------------------------|
| Material | stainless steel |
| Finish | brushed |
| Item no. | N1929 |
| Dimensions in mm | height 250 / projection 300 / c-c 600 |

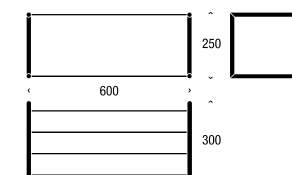

SHOE SHELF 2

| | |
|------------------|--|
| Material | stainless steel |
| Finish | brushed |
| Item no. | N1929-1 |
| Dimensions in mm | height 250 / projection 300 / c-c 1000 |

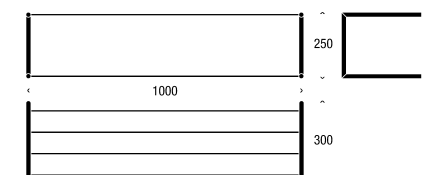

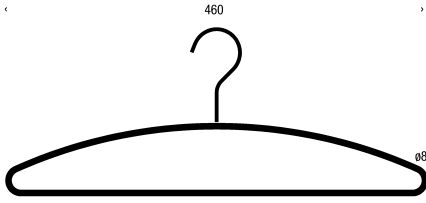
| HANGER 1b | |
|---|---|
| Material | stainless steel |
| Finish | brushed |
| Item no. | N1134b |
| Dimensions in mm | diameter $\varnothing 8$ / o/a length 460 |
|  | |

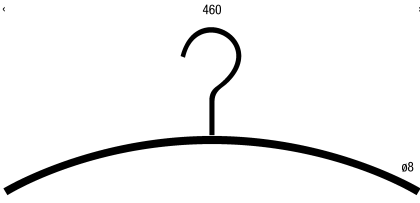

| HANGER 1 | | |
|---|---|----------|
| Material | stainless steel | |
| Finish | brushed | polished |
| Item no. | N1134 | O1134 |
| Dimensions in mm | diameter $\varnothing 8$ / o/a length 460 | |
|  | | |

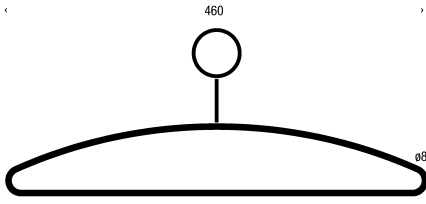
| HANGER 1c | |
|---|---|
| Material | stainless steel |
| Finish | brushed |
| Item no. | N1134c |
| Dimensions in mm | diameter $\varnothing 8$ / o/a length 460 |
|  | |

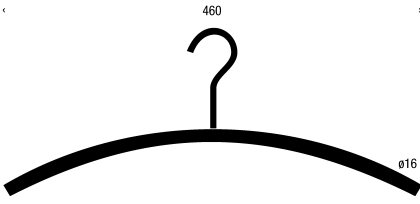

| HANGER 2 | | |
|---|--|----------|
| Material | stainless steel | |
| Finish | brushed | polished |
| Item no. | N1135 | O1135 |
| Dimensions in mm | diameter $\varnothing 16$ / o/a length 460mm | |
|  | | |

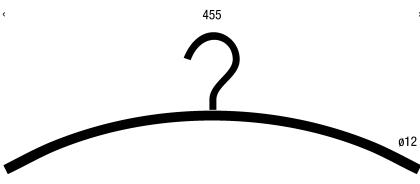

| HANGER 3 SWIVEL | | |
|---|--|----------|
| Material | stainless steel | |
| Finish | brushed | polished |
| Item no. | N1136 | O1136 |
| Dimensions in mm | diameter $\varnothing 12$ / o/a length 455 | |
|  | | |



HALL STAND 1, FLOOR

| | | |
|------------------|-----------------------------|----------|
| Material | stainless steel | |
| Finish | brushed | polished |
| Item no. | N1176 | O1176 |
| Dimensions in mm | diameter ø300 / height 1700 | |



HALL STAND 2, WALL

| | | |
|------------------|--|----------|
| Material | stainless steel | |
| Finish | brushed | polished |
| Item no. | N1177 | O1177 |
| Dimensions in mm | diameter ø100 / height 1700 / projection 350 | |

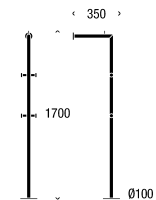

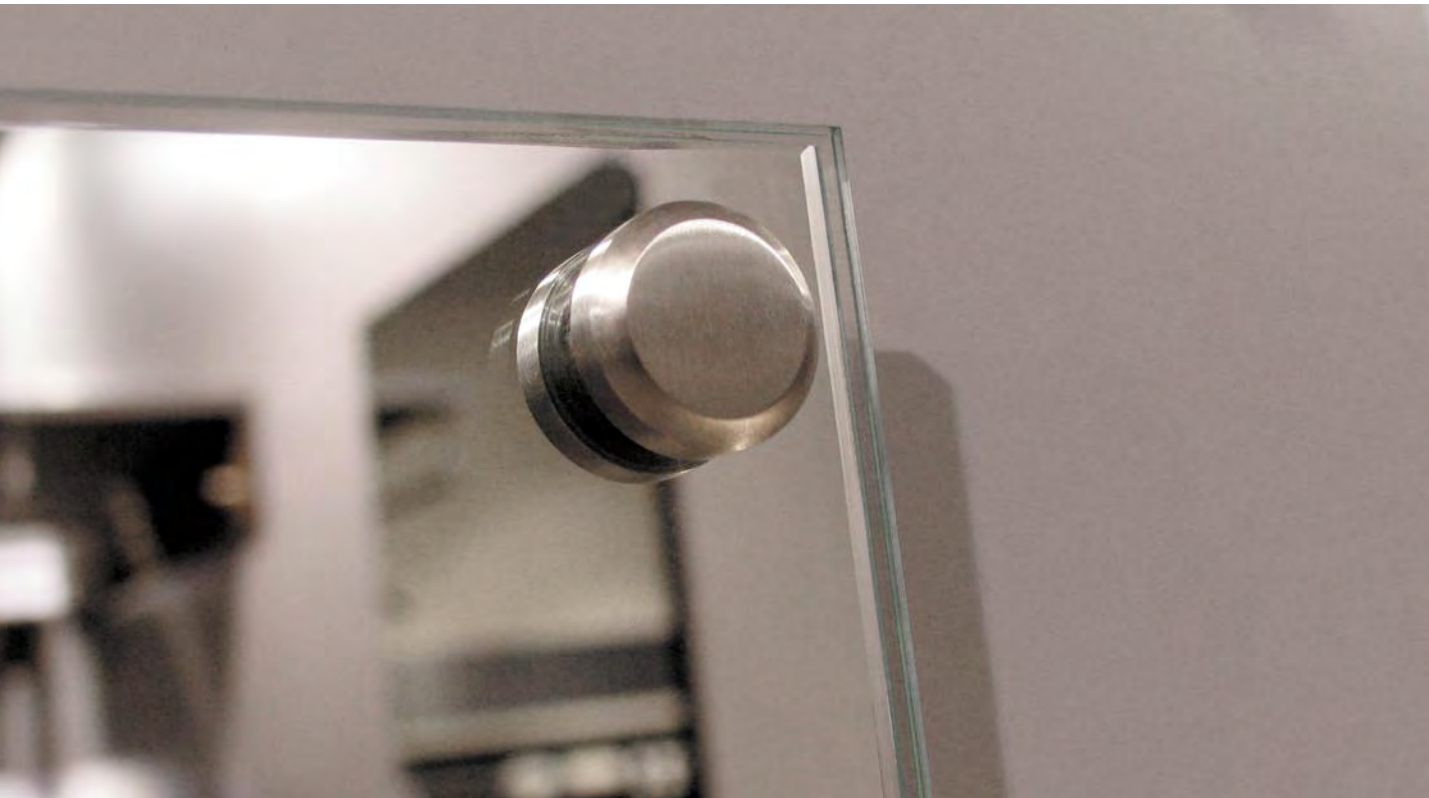

| GLASS SIGN HOLDERS 4 PCS. A SET | | |
|---------------------------------|--|----------|
| Material | stainless steel | |
| Finish | brushed | polished |
| Item no. | N1181 | O1181 |
| Dimensions in mm | diameter $\varnothing 20$ / projection 6 | |



| FEET 1 2 PCS. A SET | |
|---------------------|---|
| Material | stainless steel |
| Finish | brushed |
| Item no. | N1801 |
| Dimensions in mm | diameter $\varnothing 70$ & 60 / height 100 |



| FEET 2 2 PCS. A SET | |
|---------------------|---|
| Material | stainless steel |
| Finish | brushed |
| Item no. | N1802 |
| Dimensions in mm | diameter $\varnothing 70$ & 60 / height 150 |



| FEET 3 2 PCS. A SET | |
|---------------------|---|
| Material | stainless steel |
| Finish | brushed |
| Item no. | N1803 |
| Dimensions in mm | diameter $\varnothing 70$ & 60 / height 195 |

MIRRORS & SHELVES

QUADRA » Shelf Bracket 3 » Q3005.120.45 » page 98



| MIRROR 1 | |
|------------------|--------------------------------------|
| Material | mirror |
| Finish | polished edge |
| Item no. | NS1 |
| Dimensions in mm | width 600 / height 120 / thickness 5 |
| | |

| MIRROR 2 | |
|------------------|--------------------------------------|
| Material | mirror |
| Finish | polished edge |
| Item no. | NS2 |
| Dimensions in mm | width 100 / height 120 / thickness 5 |
| | |



| MIRROR UNO | |
|------------------|--------------------------------------|
| Material | mirror |
| Finish | polished edge |
| Item no. | U3009 |
| Dimensions in mm | width 600 / height 950 / thickness 5 |
| | |

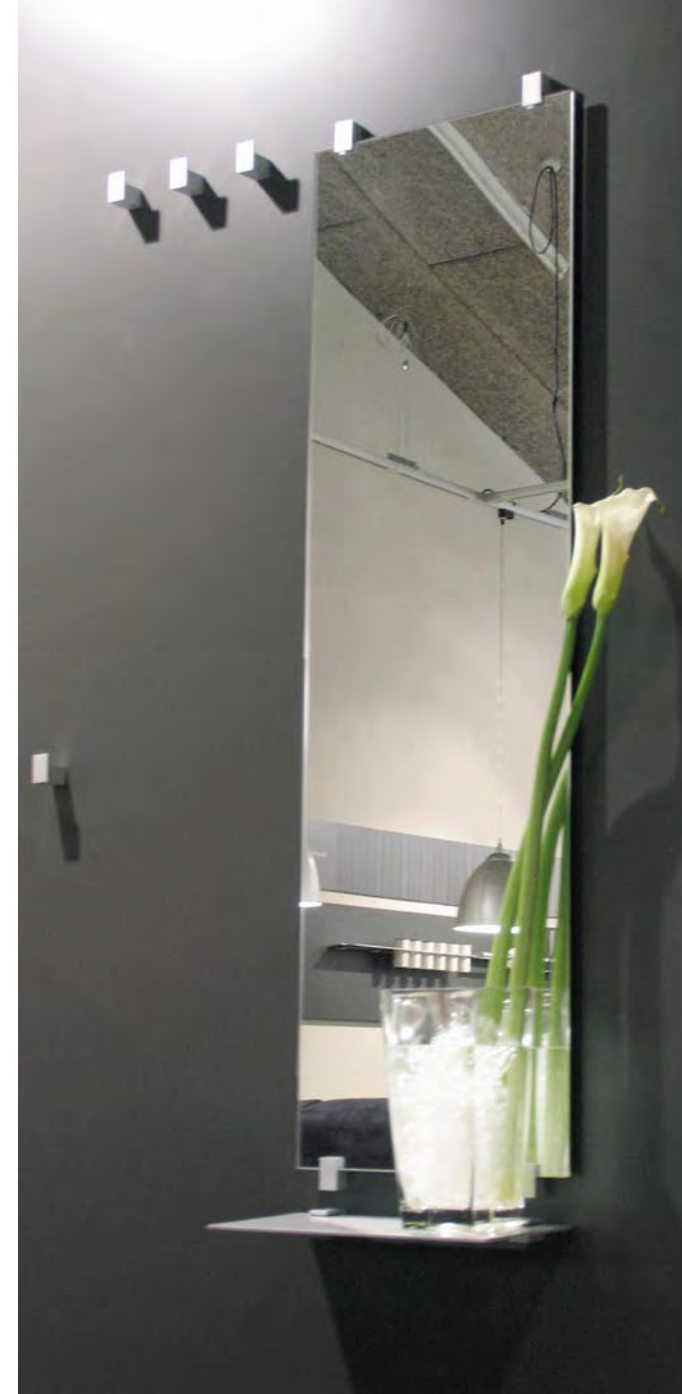

| MIRROR 3 | |
|------------------|--------------------------------------|
| Material | mirror |
| Finish | polished edge |
| Item no. | NS3 |
| Dimensions in mm | width 500 / height 600 / thickness 5 |
| | |

| MIRROR 5 | |
|------------------|---------------------------------------|
| Material | mirror |
| Finish | polished edge |
| Item no. | NS5 |
| Dimensions in mm | width 360 / height 1150 / thickness 5 |
| | |

| GLASS SHELF 1 | |
|------------------|--------------------------------------|
| Material | clear glass |
| Finish | polished edge |
| Item no. | NG1 |
| Dimensions in mm | width 600 / depth 120 / thickness 10 |
| | |

| GLASS SHELF 2 | |
|------------------|--------------------------------------|
| Material | clear glass |
| Finish | polished edge |
| Item no. | NG2 |
| Dimensions in mm | width 600 / depth 200 / thickness 10 |
| | |

| GLASS SHELF 3 | |
|------------------|--------------------------------------|
| Material | clear glass |
| Finish | polished edge |
| Item no. | NG3 |
| Dimensions in mm | width 360 / depth 165 / thickness 10 |
| | |

| GLASS SHELF 4 | |
|------------------|--------------------------------------|
| Material | clear glass |
| Finish | polished edge |
| Item no. | NG4 |
| Dimensions in mm | width 800 / depth 200 / thickness 10 |
| | |

| CD GLASS SHELF | |
|------------------|--------------------------------------|
| Material | clear glass |
| Finish | polished edge |
| Item no. | NG5 |
| Dimensions in mm | width 120 / depth 170 / thickness 10 |
| | |

| CORNER SHELF | |
|------------------|--------------------------------------|
| Material | clear glass |
| Finish | polished edge |
| Item no. | NG6 |
| Dimensions in mm | width 170 / depth 170 / thickness 10 |
| | |

| HALL SHELF | |
|------------------|--------------------------------------|
| Material | clear glass |
| Finish | polished edge |
| Item no. | NG7 |
| Dimensions in mm | width 500 / depth 170 / thickness 10 |
| | |



QUADRA » Shelf Bracket 3 » Q3005.120.45 » page 98

Wall » H2563.160.05 » page 133

QUADRA HANDLE 1

| Material | Finish | Item no. | CC total width = cc + 14mm |
|-----------|-----------------------|--------------|----------------------------|
| aluminium | anodized (A) | Q3007.032.45 | 32 mm |
| | | Q3007.128.45 | 128 mm |
| | | Q3007.160.45 | 160 mm |
| | | Q3007.224.45 | 224 mm |
| zinc | brushed stainless (B) | Q3007.032.10 | 32 mm |
| | | Q3007.128.10 | 128 mm |
| | | Q3007.160.10 | 160 mm |
| | | Q3007.224.10 | 224 mm |
| zinc | polished chrome (C) | Q3007.032.25 | 32 mm |
| | | Q3007.128.25 | 128 mm |
| | | Q3007.160.25 | 160 mm |
| | | Q3007.224.25 | 224 mm |

QUADRA HANDLE 2

| Material | Finish | Item no. | CC total width = cc + 14mm |
|-----------|-----------------------|--------------|----------------------------|
| aluminium | anodized (A) | Q3008.032.45 | 32 mm |
| | | Q3008.128.45 | 128 mm |
| | | Q3008.160.45 | 160 mm |
| | | Q3008.224.45 | 224 mm |
| zinc | brushed stainless (B) | Q3008.032.10 | 32 mm |
| | | Q3008.128.10 | 128 mm |
| | | Q3008.160.10 | 160 mm |
| | | Q3008.224.10 | 224 mm |
| zinc | polished chrome (C) | Q3008.032.25 | 32 mm |
| | | Q3008.128.25 | 128 mm |
| | | Q3008.160.25 | 160 mm |
| | | Q3008.224.25 | 224 mm |





QUADRA HANDLE 3

| Material | Finish | Item no. | CC total width = cc + 20mm |
|-----------|-----------------------|--------------|----------------------------|
| aluminium | anodized (A) | Q3009.128.45 | 128 mm |
| | | Q3009.160.45 | 160 mm |
| | | Q3009.224.45 | 224 mm |
| brass | brushed stainless (B) | Q3009.128.10 | 128 mm |
| | | Q3009.160.10 | 160 mm |
| | | Q3009.224.10 | 224 mm |
| brass | polished chrome (C) | Q3009.128.25 | 128 mm |
| | | Q3009.160.25 | 160 mm |
| | | Q3009.224.25 | 224 mm |

QUADRA HANDLE 4



| Material | Finish | Item no. | CC total width = cc + 20mm |
|-----------|-----------------------|--------------|----------------------------|
| aluminium | anodized (A) | Q3010.128.45 | 128 mm |
| | | Q3010.160.45 | 160 mm |
| | | Q3010.224.45 | 224 mm |
| brass | brushed stainless (B) | Q3010.128.10 | 128 mm |
| | | Q3010.160.10 | 160 mm |
| | | Q3010.224.10 | 224 mm |
| brass | polished chrome (C) | Q3010.128.25 | 128 mm |
| | | Q3010.160.25 | 160 mm |
| | | Q3010.224.25 | 224 mm |

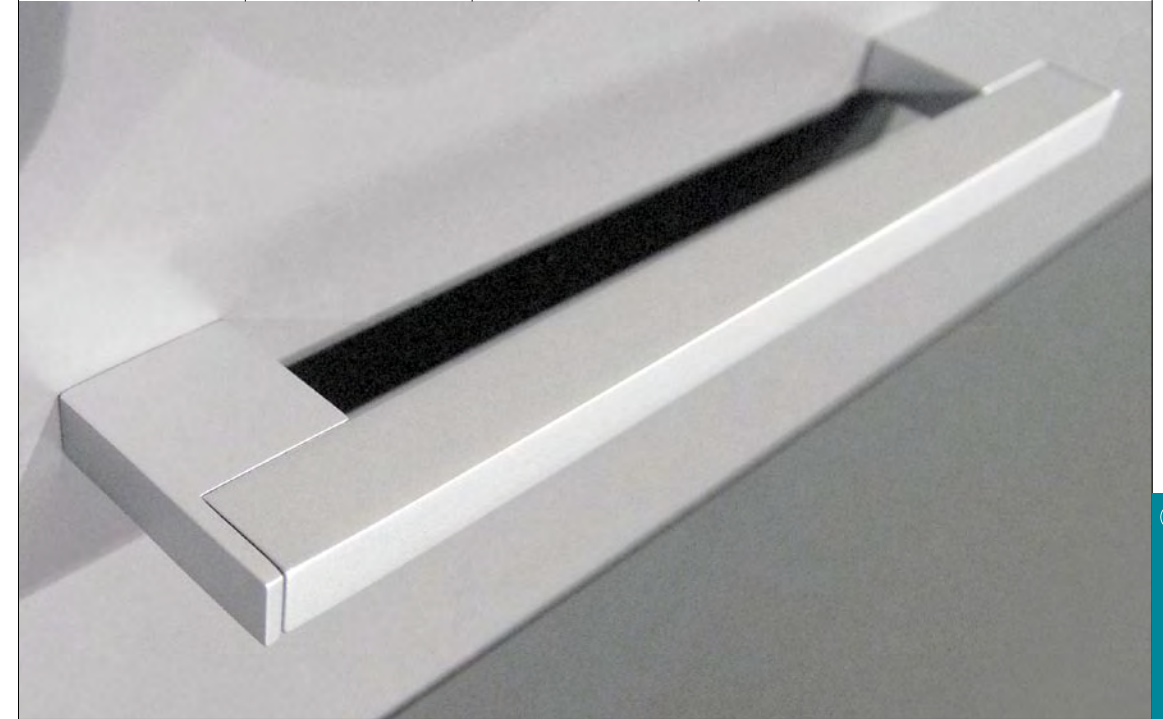



TOWER

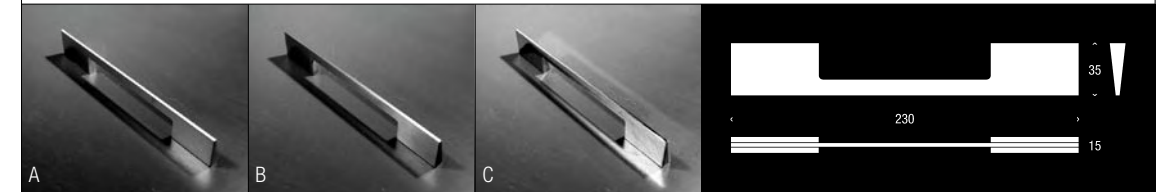

| Material | Finish | Item no. | CC total width = cc + 70mm |
|----------|-----------------------|--------------|----------------------------|
| zinc | matt chrome (A) | H2563.160.05 | 160 mm |
| zinc | brushed stainless (B) | H2563.160.10 | 160 mm |
| zinc | polished chrome (C) | H2563.160.25 | 160 mm |

WALL

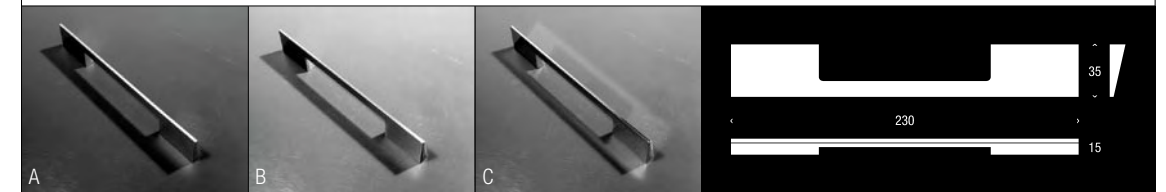

| Material | Finish | Item no. | CC total width = cc + 70mm |
|----------|-----------------------|--------------|----------------------------|
| zinc | matt chrome (A) | H2565.160.05 | 160 mm |
| zinc | brushed stainless (B) | H2565.160.10 | 160 mm |
| zinc | polished chrome (C) | H2565.160.25 | 160 mm |







BARCELONA 75MM

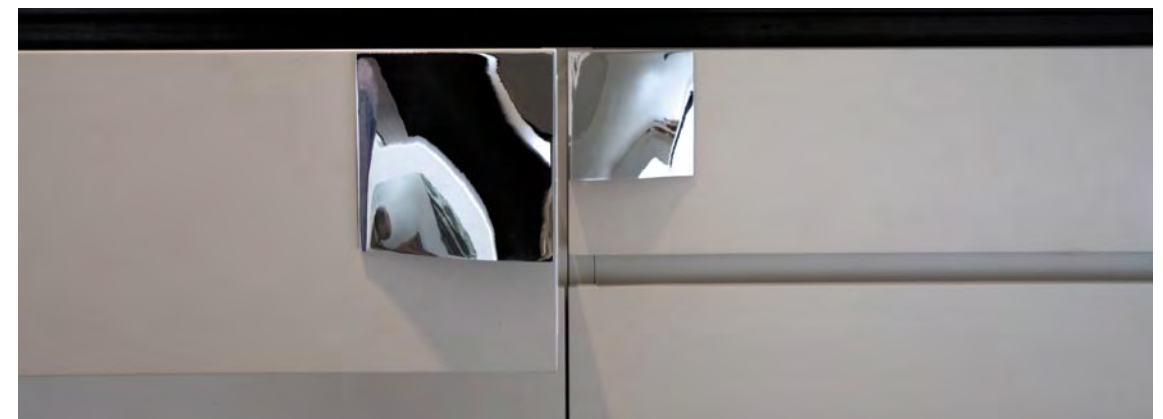



| A | B | C | |
|-----------------|-----------------------|---|-----------------------------------|
| Material | Finish | Item no. | CC total width = cc + 43mm |
| zinc | matt chrome (A) | H2021.075.05 LEFT H2021.075.05 RIGHT | 32 mm 32 mm |
| zinc | brushed stainless (B) | H2021.075.10 LEFT H2021.075.10 RIGHT | 32 mm 32 mm |
| zinc | polished chrome (C) | H2021.075.25 LEFT H2021.075.25 RIGHT | 32 mm 32 mm |

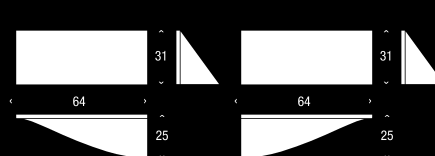





BARCELONA 32MM

|  |  |  |  |
|--|---|---|--|
| A | B | C | |
| Material | Finish | Item no. | CC total width = cc + 32mm |
| zinc | matt chrome (A) | H2021.032.05 LEFT H2021.032.05 RIGTH | 32 mm 32 mm |
| zinc | brushed stainless (B) | H2021.032.10 LEFT H2021.032.10 RIGTH | 32 mm 32 mm |
| zinc | polished chrome (C) | H2021.032.25 LEFT H2021.032.25 RIGHT | 32 mm 32 mm |





BARCELONA CC 96MM

|  |  |  |  |
|--|---|---|--|
| A | B | C | |
| Material | Finish | Item no. | CC total width = cc + 34mm |
| zinc | matt chrome (A) | H2021.096.05 | 96 mm |
| zinc | brushed stainless (B) | H2021.096.10 | 96 mm |
| zinc | polished chrome (C) | H2021.096.25 | 96 mm |

BARCELONA 128MM

|  |  |  |  |
|--|---|---|--|
| A | B | C | |
| Material | Finish | Item no. | CC total width = cc + 84mm |
| zinc | matt chrome (A) | H2021.128.05 | 96 mm |
| zinc | brushed stainless (B) | H2021.128.10 | 96 mm |
| zinc | polished chrome (C) | H2021.128.25 | 96 mm |

BARCELONA CC 192MM

|  |  |  |  |
|--|---|---|--|
| A | B | C | |
| Material | Finish | Item no. | CC total width = cc + 84mm |
| zinc | matt chrome (A) | H2021.192.05 | 192 mm |
| zinc | brushed stainless (B) | H2021.192.10 | 192 mm |
| zinc | polished chrome (C) | H2021.192.25 | 192 mm |



SKYLINE

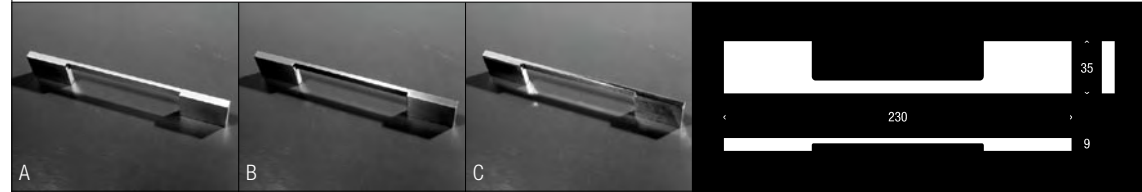

| Material | Finish | Item no. | CC total width = cc + 70mm |
|----------|-----------------------|--------------|----------------------------|
| zinc | matt chrome (A) | H2564.160.05 | 160 mm |
| zinc | brushed stainless (B) | H2564.160.10 | 160 mm |
| zinc | polished chrome (C) | H2564.160.25 | 160 mm |

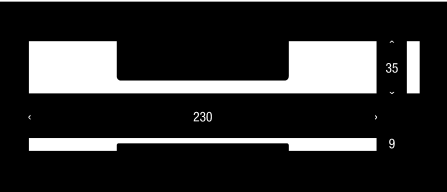

ARKI+ 45MM

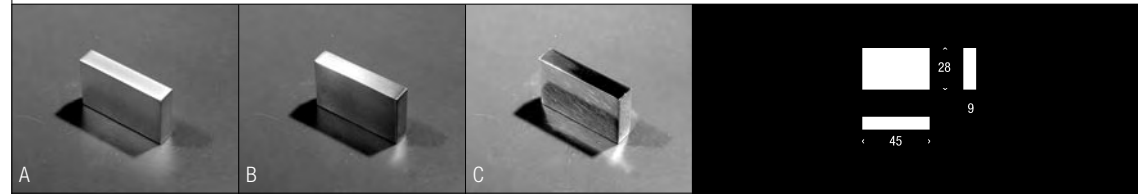

| Material | Finish | Item no. | CC total width = cc + 13mm |
|----------|-----------------------|--------------|----------------------------|
| steel | matt chrome (A) | H2547.032.05 | 32 mm |
| steel | brushed stainless (B) | H2547.032.10 | 32 mm |
| steel | polished chrome (C) | H2547.032.25 | 32 mm |

ARKI+ 74MM

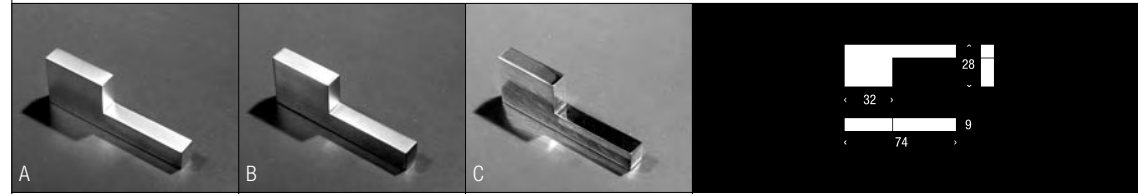

| Material | Finish | Item no. | CC total width = cc + 10mm |
|----------|-----------------------|--------------|----------------------------|
| steel | matt chrome (A) | H2542.064.05 | 64 mm |
| steel | brushed stainless (B) | H2542.064.10 | 64 mm |
| steel | polished chrome (C) | H2542.064.25 | 64 mm |

ARKI+ 74MM REVERSE

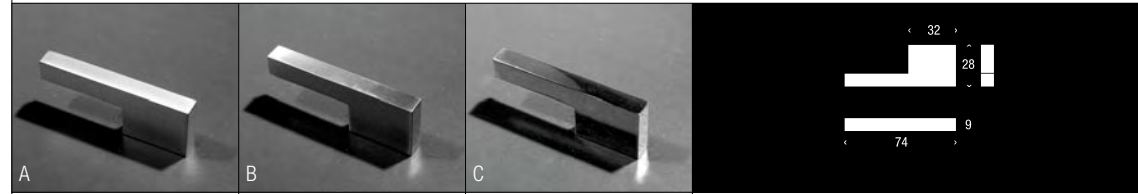

| Material | Finish | Item no. | CC total width = cc + 58mm |
|----------|-----------------------|--------------|----------------------------|
| steel | matt chrome (A) | H2543.016.05 | 16 mm |
| steel | brushed stainless (B) | H2543.016.10 | 16 mm |
| steel | polished chrome (C) | H2543.016.25 | 16 mm |

ARKI+ 188MM

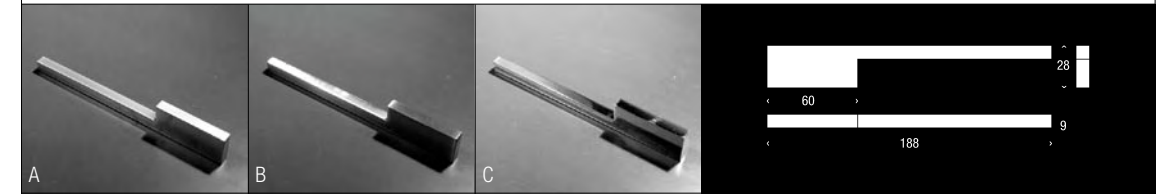

| Material | Finish | Item no. | CC total width = cc + 28mm |
|----------|-----------------------|--------------|----------------------------|
| steel | matt chrome (A) | H2541.160.05 | 160 mm |
| steel | brushed stainless (B) | H2541.160.10 | 160 mm |
| steel | polished chrome (C) | H2541.160.25 | 160 mm |

ARKI+ 188MM REVERSE

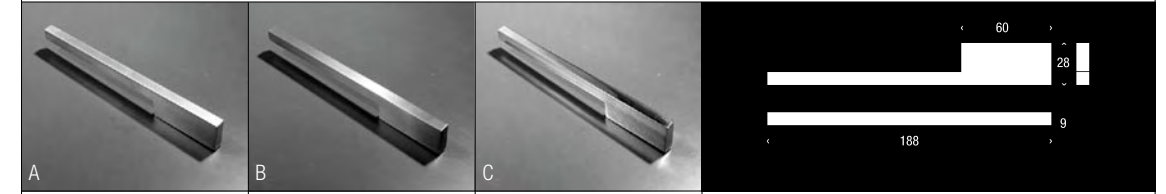

| Material | Finish | Item no. | CC total width = cc + 156mm |
|----------|-----------------------|--------------|-----------------------------|
| steel | matt chrome (A) | H2548.032.05 | 32 mm |
| steel | brushed stainless (B) | H2548.032.10 | 32 mm |
| steel | polished chrome (C) | H2548.032.25 | 32 mm |

ARKI+ 512MM

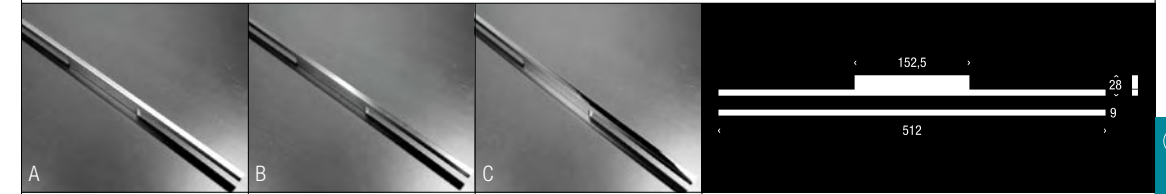

| Material | Finish | Item no. | CC total width = cc + 384mm |
|----------|-----------------------|--------------|-----------------------------|
| steel | matt chrome (A) | H2545.128.05 | 128 mm |
| steel | brushed stainless (B) | H2545.128.10 | 128 mm |
| steel | polished chrome (C) | H2545.128.25 | 128 mm |

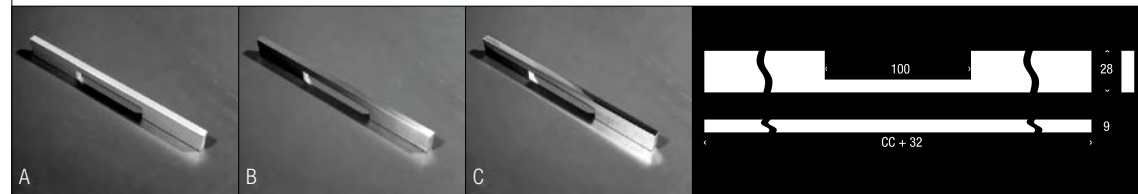
ARKI+ SYMMETRICAL

| Material | Finish | Item no. | CC total width = cc + 32mm |
|-----------|-----------------------|---------------|----------------------------|
| aluminium | anodized (A) | H3034.256C.45 | 128 / 224 mm |
| | | H3034.352C.45 | 128 / 320 mm |
| | | H3034.448C.45 | 128 / 416 mm |
| | | H3034.512C.45 | 128 / 512 mm |
| | | H3034.640C.45 | 128 / 608 mm |
| | | H3034.672C.45 | 128 / 640 mm |
| | | H3034.736C.45 | 128 / 704 mm |
| | | H3034.832C.45 | 128 / 800 mm |
| steel | brushed stainless (B) | H2520.256C.10 | 128 / 224 mm |
| | | H2520.352C.10 | 128 / 320 mm |
| | | H2520.448C.10 | 128 / 416 mm |
| | | H2520.512C.10 | 128 / 480 mm |
| | | H2520.640C.10 | 128 / 608 mm |
| | | H2520.672C.10 | 128 / 640 mm |
| | | H2520.736C.10 | 128 / 704 mm |
| | | H2520.832C.10 | 128 / 800 mm |
| steel | polished chrome (C) | H2520.256C.25 | 128 / 224 mm |
| | | H2520.352C.25 | 128 / 320 mm |
| | | H2520.448C.25 | 128 / 416 mm |
| | | H2520.512C.25 | 128 / 480 mm |
| | | H2520.640C.25 | 128 / 608 mm |
| | | H2520.672C.25 | 128 / 640 mm |
| | | H2520.736C.25 | 128 / 704 mm |
| | | H2520.832C.25 | 128 / 800 mm |

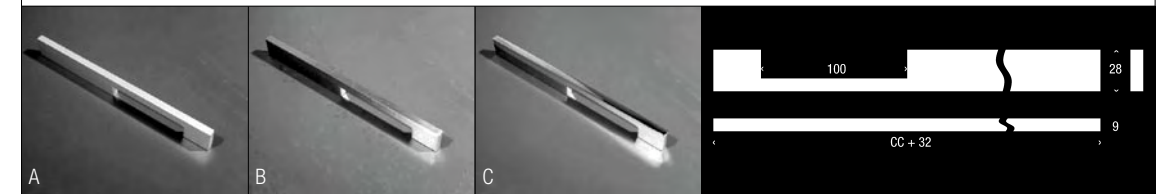
ARKI+ ASYMMETRICAL

| Material | Finish | Item no. | CC total width = cc + 32mm |
|-----------|-----------------------|--------------|----------------------------|
| aluminium | anodized (A) | H3034.256.45 | 128 + 96 mm |
| | | H3034.352.45 | 128+192 mm |
| | | H3034.448.45 | 128+288 mm |
| steel | brushed stainless (B) | H2520.256.10 | 128 + 96 mm |
| | | H2520.352.10 | 128+192 mm |
| | | H2520.448.10 | 128+288 mm |
| steel | polished chrome (C) | H2520.256.25 | 128 + 96 mm |
| | | H2520.352.25 | 128+192 mm |
| | | H2520.448.25 | 128+288 mm |

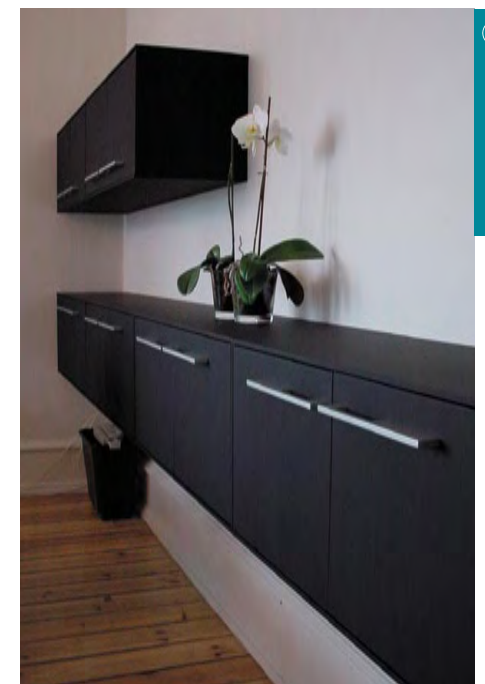



Beat » Ø16 » page 147

Beat » Ø12 » page 146

Mountain » Ø14 » page 149

Mountain » Ø10 » page 148

BEAT Ø12MM

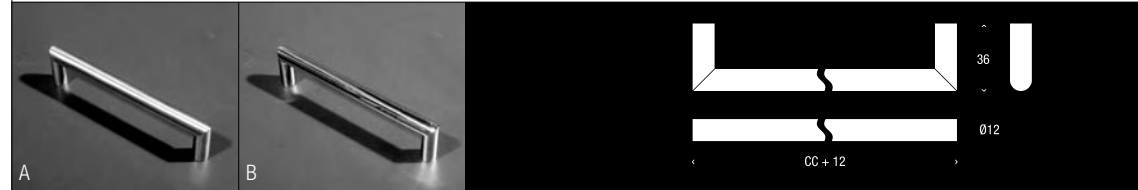

| Material | Finish | Item no. | CC total width = cc + 12mm |
|-----------------|--------------|--------------|----------------------------|
| stainless steel | brushed (A) | H1018.128.01 | 128 mm |
| | | H1018.160.01 | 160 mm |
| | | H1018.192.01 | 192 mm |
| | | H1018.224.01 | 224 mm |
| | | H1018.288.01 | 288 mm |
| | | H1018.320.01 | 320 mm |
| | | H1018.416.01 | 416 mm |
| | | H1018.480.01 | 480 mm |
| | | H1018.512.01 | 512 mm |
| | | H1018.640.01 | 640 mm |
| | | H1018.672.01 | 672 mm |
| | | H1018.736.01 | 736 mm |
| | | H1018.832.01 | 832 mm |
| stainless steel | polished (B) | H1018.128.40 | 128 mm |
| | | H1018.160.40 | 160 mm |
| | | H1018.192.40 | 192 mm |
| | | H1018.224.40 | 224 mm |
| | | H1018.288.40 | 288 mm |
| | | H1018.320.40 | 320 mm |
| | | H1018.416.40 | 416 mm |
| | | H1018.480.40 | 480 mm |
| | | H1018.512.40 | 512 mm |
| | | H1018.640.40 | 640 mm |
| H1018.672.40 | 672 mm | | |
| H1018.736.40 | 736 mm | | |
| H1018.832.40 | 832 mm | | |

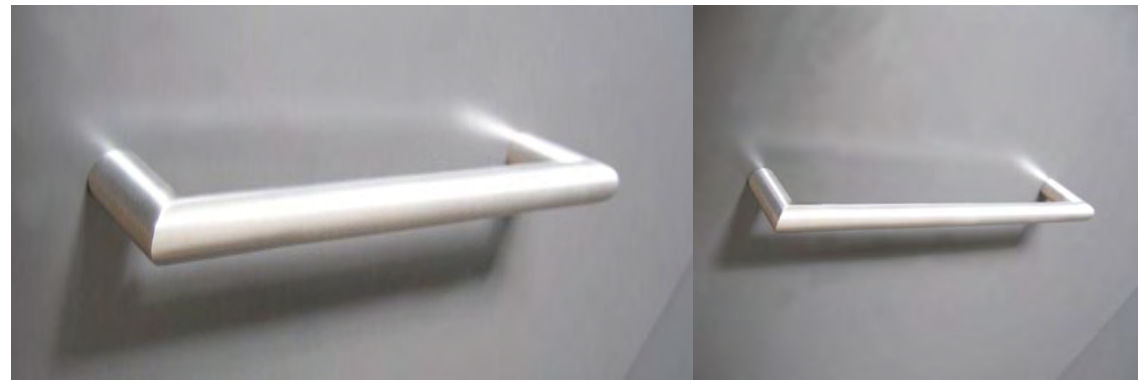

BEAT Ø10MM

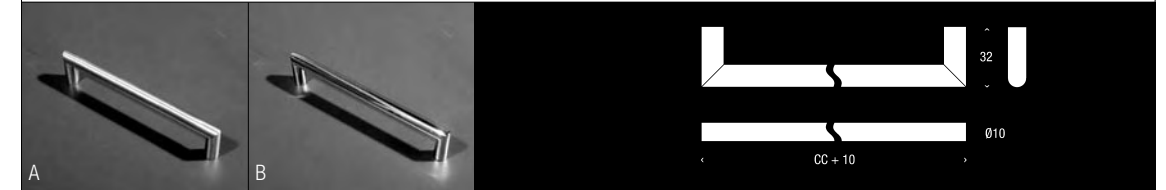

| Material | Finish | Item no. | CC total width = cc + 10mm |
|-----------------|--------------|--------------|----------------------------|
| stainless steel | brushed (A) | H1118.128.01 | 128 mm |
| | | H1118.160.01 | 160 mm |
| | | H1118.192.01 | 192 mm |
| | | H1118.224.01 | 224 mm |
| | | H1118.320.01 | 320 mm |
| | | H1118.416.01 | 416 mm |
| | | H1118.512.01 | 512 mm |
| stainless steel | polished (B) | H1118.128.40 | 128 mm |
| | | H1118.160.40 | 160 mm |
| | | H1118.192.40 | 192 mm |
| | | H1118.224.40 | 224 mm |
| | | H1118.320.40 | 320 mm |
| | | H1118.416.40 | 416 mm |
| | | H1118.512.40 | 512 mm |

BEAT Ø16MM

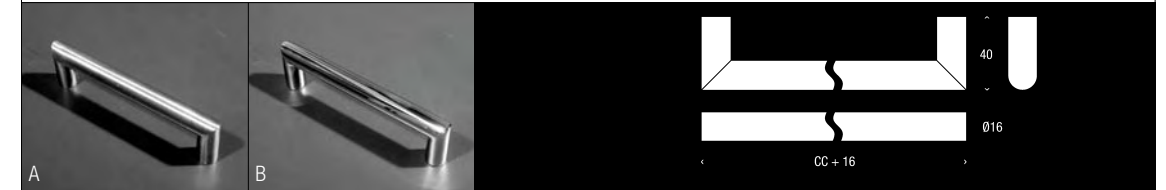

| Material | Finish | Item no. | CC total width = cc + 16mm |
|-----------------|--------------|--------------|----------------------------|
| stainless steel | brushed (A) | H1019.128.01 | 128 mm |
| | | H1019.160.01 | 160 mm |
| | | H1019.192.01 | 192 mm |
| | | H1019.224.01 | 224 mm |
| | | H1019.320.01 | 320 mm |
| | | H1019.416.01 | 416 mm |
| | | H1019.512.01 | 512 mm |
| stainless steel | polished (B) | H1019.128.40 | 128 mm |
| | | H1019.160.40 | 160 mm |
| | | H1019.192.40 | 192 mm |
| | | H1019.224.40 | 224 mm |
| | | H1019.320.40 | 320 mm |
| | | H1019.416.40 | 416 mm |
| | | H1019.512.40 | 512 mm |

MOUNTAIN Ø10MM

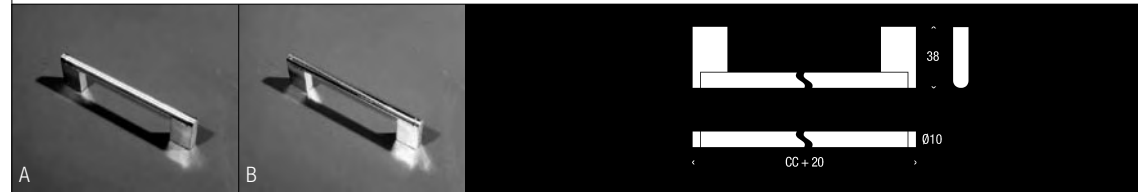

| Material | Finish | Item no. | CC total width = cc + 20mm |
|-----------------|--------------|--------------|----------------------------|
| stainless steel | brushed (A) | H1016.128.01 | 128 mm |
| | | H1016.160.01 | 160 mm |
| | | H1016.192.01 | 192 mm |
| | | H1016.224.01 | 224 mm |
| | | H1016.320.01 | 320 mm |
| | | H1016.416.01 | 416 mm |
| | | H1016.512.01 | 512 mm |
| | | H1016.640.01 | 640 mm |
| | | H1016.736.01 | 736 mm |
| stainless steel | polished (B) | H1016.128.40 | 128 mm |
| | | H1016.160.40 | 160 mm |
| | | H1016.192.40 | 192 mm |
| | | H1016.224.40 | 224 mm |
| | | H1016.320.40 | 320 mm |
| | | H1016.416.40 | 416 mm |
| | | H1016.512.40 | 512 mm |
| | | H1016.640.40 | 640 mm |
| | | H1016.736.40 | 736 mm |
| H1016.832.40 | 832 mm | | |



MOUNTAIN Ø14MM

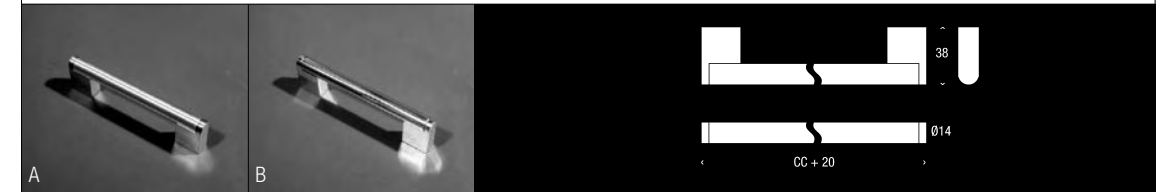

| Material | Finish | Item no. | CC total width = cc + 20mm | | |
|-----------------|-------------|-----------------|----------------------------|--------------|--------|
| stainless steel | brushed (A) | H1416.128.01 | 128 mm | | |
| | | H1416.160.01 | 160 mm | | |
| | | H1416.192.01 | 192 mm | | |
| | | H1416.224.01 | 224 mm | | |
| | | H1416.320.01 | 320 mm | | |
| | | H1416.416.01 | 416 mm | | |
| | | H1416.512.01 | 512 mm | | |
| | | stainless steel | polished (B) | H1416.128.40 | 128 mm |
| | | | | H1416.160.40 | 160 mm |
| H1416.192.40 | 192 mm | | | | |
| H1416.224.40 | 224 mm | | | | |
| H1416.320.40 | 320 mm | | | | |
| H1416.416.40 | 416 mm | | | | |
| H1416.512.40 | 512 mm | | | | |



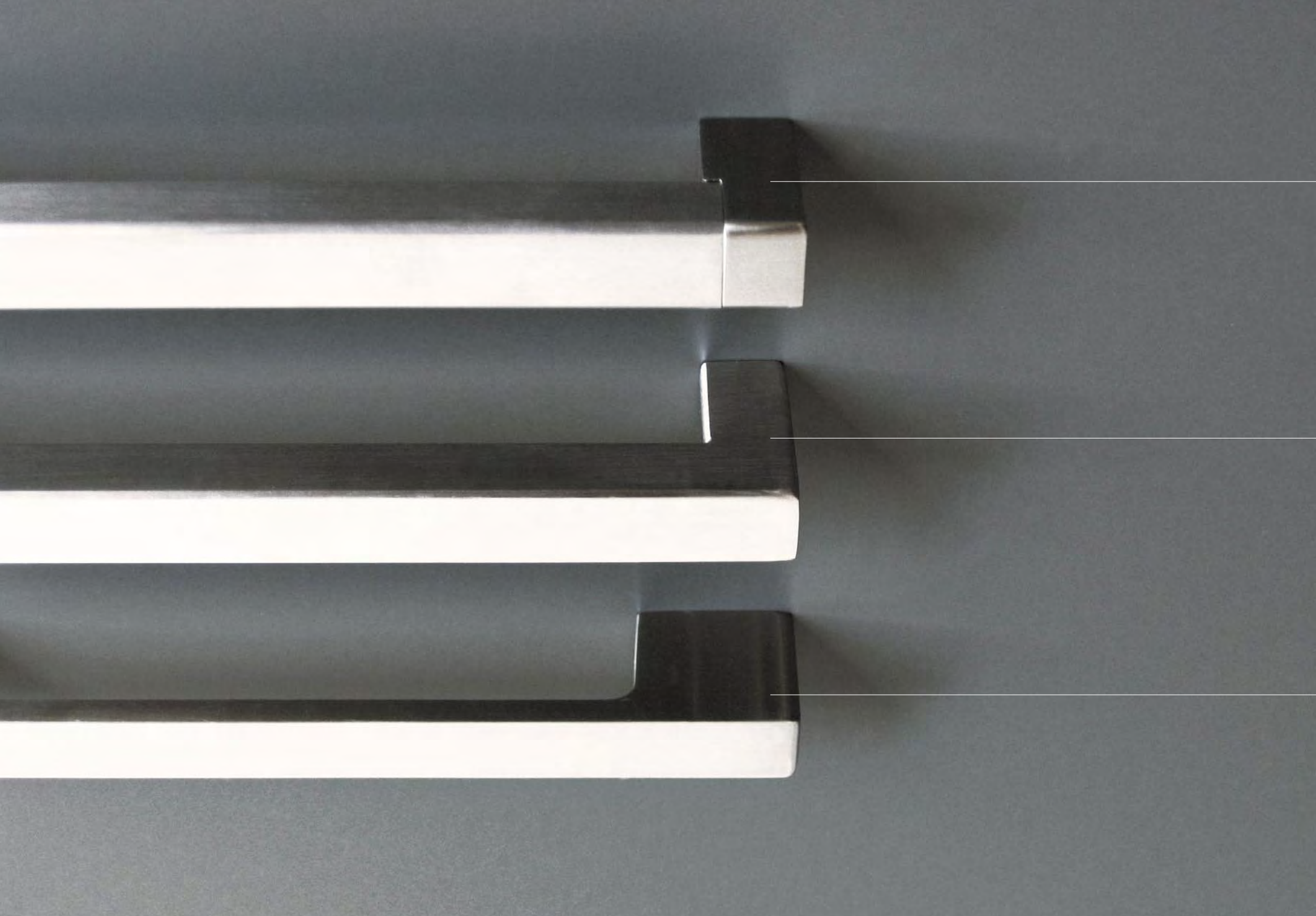

Lake » page 152

Ocean » page 153

Paris » page 154

LAKE

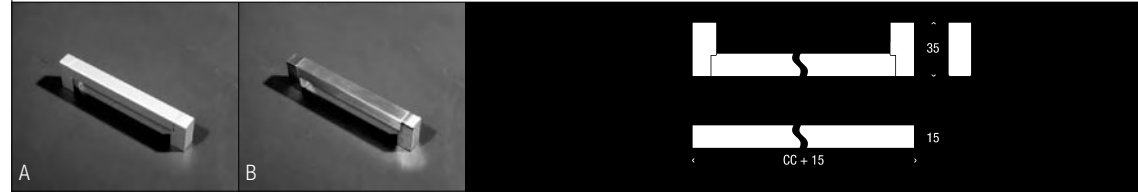

| Material | Finish | Item no. | CC total width = cc + 15mm |
|-----------------|--------------|--------------|----------------------------|
| stainless steel | brushed (A) | H1026.128.01 | 128 mm |
| | | H1026.160.01 | 160 mm |
| | | H1026.192.01 | 192 mm |
| | | H1026.224.01 | 224 mm |
| | | H1026.320.01 | 320 mm |
| | | H1026.416.01 | 416 mm |
| | | H1026.512.01 | 512 mm |
| stainless steel | polished (B) | H1026.128.40 | 128 mm |
| | | H1026.160.40 | 160 mm |
| | | H1026.192.40 | 192 mm |
| | | H1026.224.40 | 224 mm |
| | | H1026.320.40 | 320 mm |
| | | H1026.416.40 | 416 mm |
| | | H1026.512.40 | 512 mm |

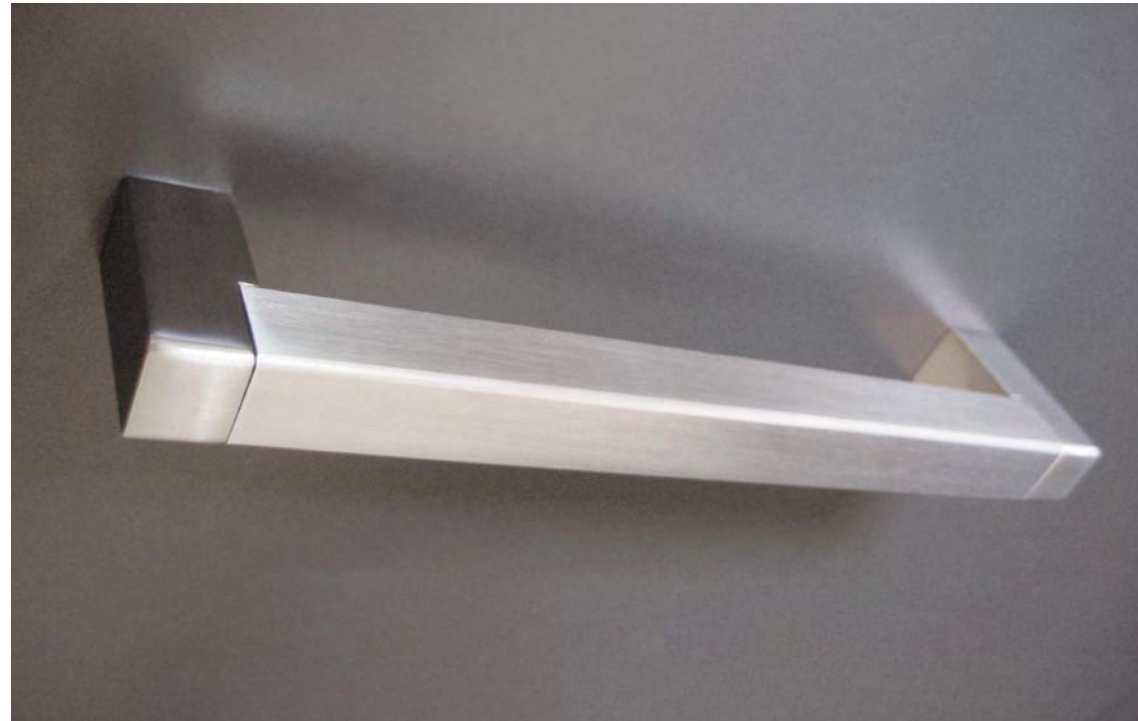

OCEAN

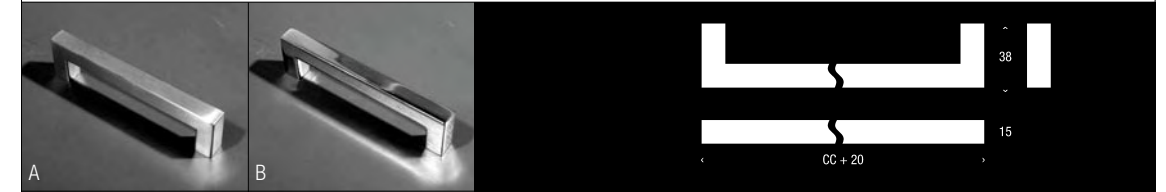

| Material | Finish | Item no. | CC total width = cc + 20mm |
|-----------------|--------------|--------------|----------------------------|
| stainless steel | brushed (A) | H1027.128.01 | 128 mm |
| | | H1027.160.01 | 160 mm |
| | | H1027.192.01 | 192 mm |
| | | H1027.224.01 | 224 mm |
| | | H1027.320.01 | 320 mm |
| | | H1027.416.01 | 416 mm |
| | | H1027.512.01 | 512 mm |
| stainless steel | polished (B) | H1027.128.40 | 128 mm |
| | | H1027.160.40 | 160 mm |
| | | H1027.192.40 | 192 mm |
| | | H1027.224.40 | 224 mm |
| | | H1027.320.40 | 320 mm |
| | | H1027.416.40 | 416 mm |
| | | H1027.512.40 | 512 mm |

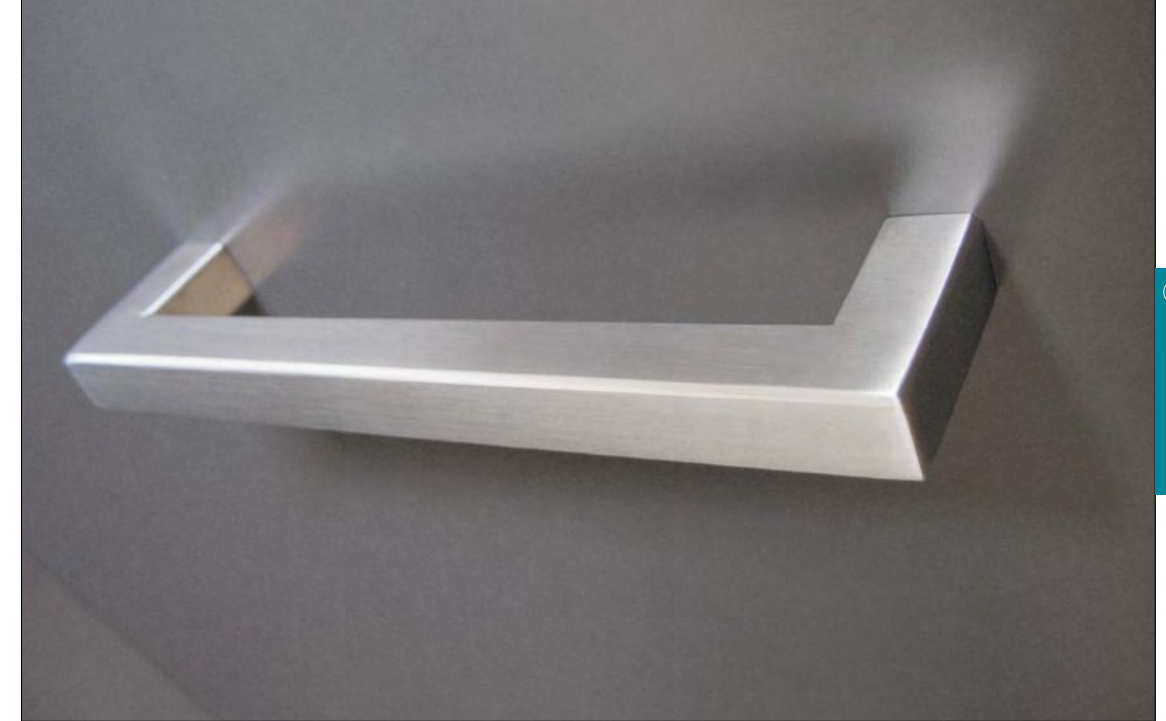

PARIS 64MM

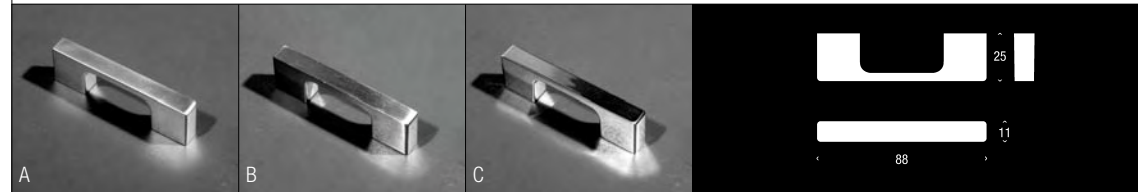

| Material | Finish | Item no. | CC total width = cc + 24mm |
|----------|-----------------------|--------------|----------------------------|
| zinc | matt chrome (A) | H2029.064.05 | 64 mm |
| zinc | brushed stainless (B) | H2029.064.10 | 64 mm |
| zinc | polished chrome (C) | H2029.064.25 | 64 mm |

PARIS 96MM

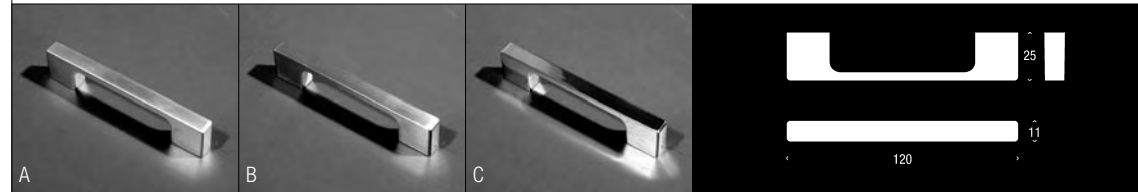

| Material | Finish | Item no. | CC total width = cc + 24mm |
|----------|-----------------------|--------------|----------------------------|
| zinc | matt chrome (A) | H2030.096.05 | 96 mm |
| zinc | brushed stainless (B) | H2030.096.10 | 96 mm |
| zinc | polished chrome (C) | H2030.096.25 | 96 mm |

PARIS 128MM

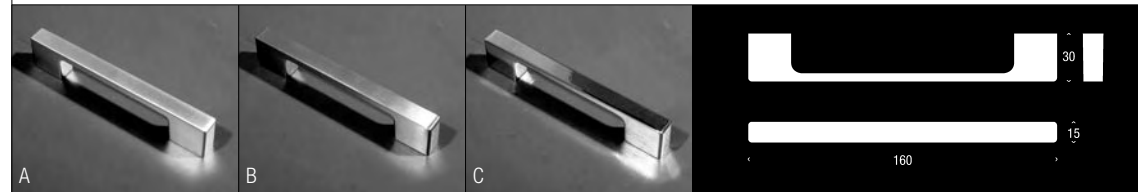

| Material | Finish | Item no. | CC total width = cc + 24mm |
|----------|-----------------------|--------------|----------------------------|
| zinc | matt chrome (A) | H2031.128.05 | 128 mm |
| zinc | brushed stainless (B) | H2031.128.10 | 128 mm |
| zinc | polished chrome (C) | H2031.128.25 | 128 mm |

PARIS 160MM

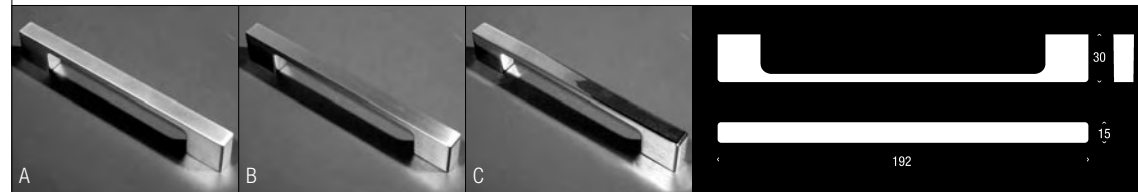

| Material | Finish | Item no. | CC total width = cc + 24mm |
|----------|-----------------------|--------------|----------------------------|
| zinc | matt chrome (A) | H2032.160.05 | 160 mm |
| zinc | brushed stainless (B) | H2032.160.10 | 160 mm |
| zinc | polished chrome (C) | H2032.160.25 | 160 mm |

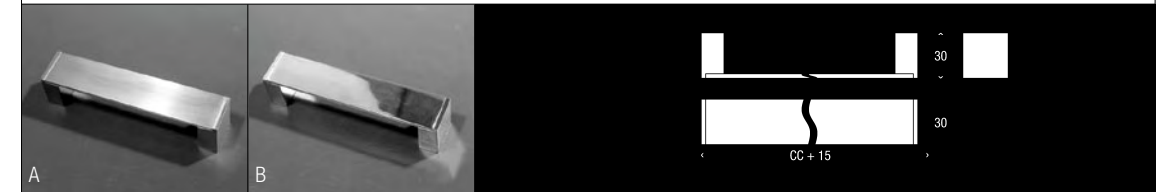

LINEA



| Material | Finish | Item no. | CC total width = cc + 15mm |
|----------|-----------------------|--------------|----------------------------|
| steel | brushed stainless (A) | H2525.128.10 | 128 mm |
| | | H2525.160.10 | 160 mm |
| | | H2525.224.10 | 224 mm |
| | | H2525.320.10 | 320 mm |
| steel | polished chrome (B) | H2525.128.25 | 128 mm |
| | | H2525.160.25 | 160 mm |
| | | H2525.224.25 | 224 mm |
| | | H2525.320.25 | 320 mm |

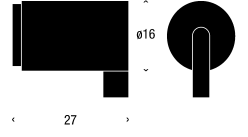

NOVA2 HANDLE 6

|  <p>A</p> |  <p>B</p> |  | |
|--|--|---|----------|
| Material | Finish | Item no. | Diameter |
| brass | brushed stainless (A) | N1901-3 | Ø16 mm |
| brass | polished chrome (B) | O1901-3 | Ø16 mm |

BRISBANE

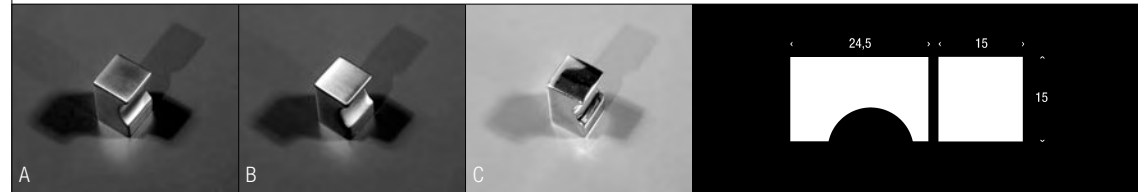

| Material | Finish | Item no. | Size |
|----------|-----------------------|--------------|-------|
| brass | matt chrome (A) | H4024.015.05 | 15 mm |
| brass | brushed stainless (B) | H4024.015.10 | 15 mm |
| brass | polished chrome (C) | H4024.015.25 | 15 mm |

BRISBANE

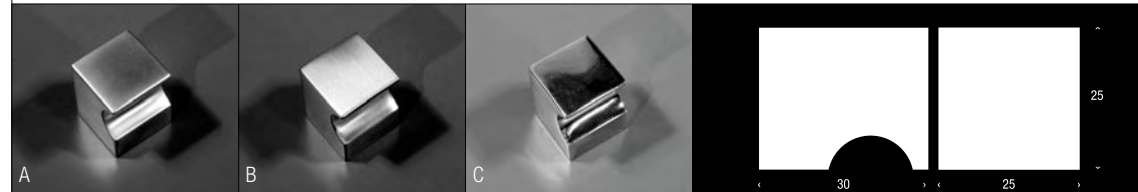

| Material | Finish | Item no. | Size |
|----------|-----------------------|--------------|-------|
| brass | matt chrome (A) | H4024.025.05 | 25 mm |
| brass | brushed stainless (B) | H4024.025.10 | 25 mm |
| brass | polished chrome (C) | H4024.025.25 | 25 mm |

MELBOURNE 12MM

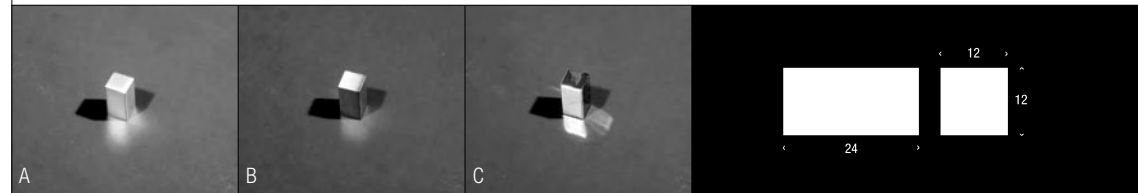

| Material | Finish | Item no. | Size |
|----------|-----------------------|--------------|-------|
| steel | matt chrome (A) | H4022.012.05 | 12 mm |
| steel | brushed stainless (B) | H4022.012.10 | 12 mm |
| steel | polished chrome (C) | H4022.012.25 | 12 mm |

MELBOURNE 16MM

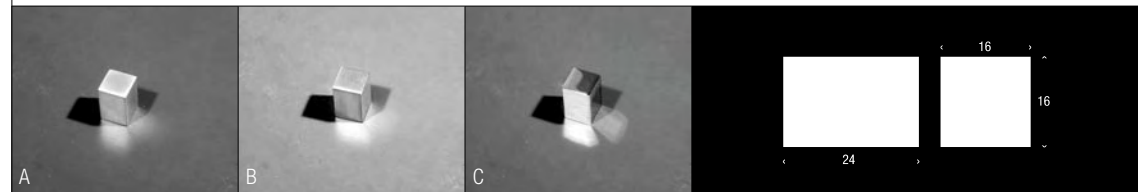

| Material | Finish | Item no. | Size |
|----------|-----------------------|--------------|-------|
| steel | matt chrome (A) | H4022.016.05 | 16 mm |
| steel | brushed stainless (B) | H4022.016.10 | 16 mm |
| steel | polished chrome (C) | H4022.016.25 | 16 mm |

PERTH KNOP

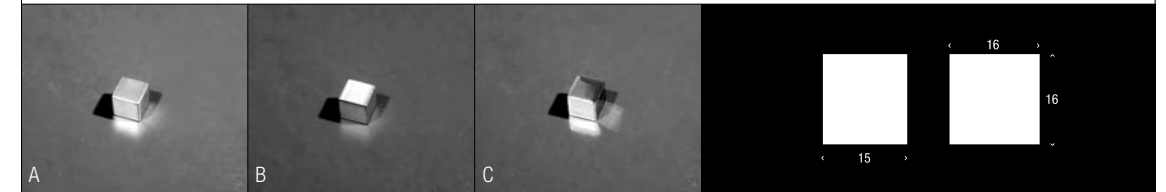

| Material | Finish | Item no. | Size |
|----------|-----------------|--------------|-------|
| steel | matt chrome (A) | H4021.015.05 | 15 mm |
| steel | brushed (B) | H4021.015.10 | 15 mm |
| steel | polished (C) | H4021.015.25 | 15 mm |

TORNADO

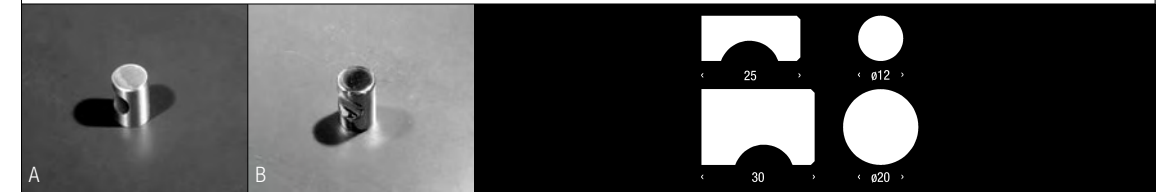

| Material | Finish | Item no. | Size |
|-----------------|--------------|--------------|--------|
| stainless steel | brushed (A) | H1001.012.01 | Ø12 mm |
| | | H1001.020.01 | Ø20 mm |
| stainless steel | polished (B) | H1001.012.40 | Ø12 mm |
| | | H1001.020.40 | Ø20 mm |

TOP

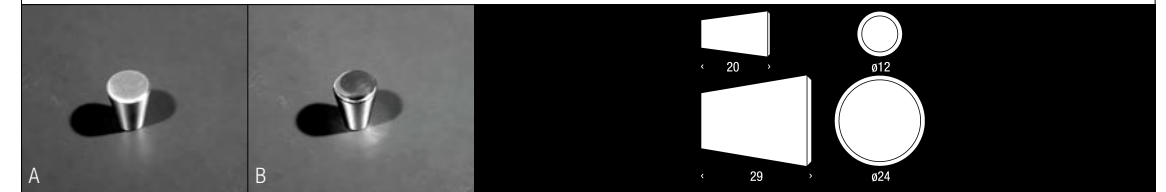

| Material | Finish | Item no. | Size |
|-----------------|--------------|--------------|--------|
| stainless steel | brushed (A) | H1003.012.01 | Ø12 mm |
| | | H1003.024.01 | Ø24 mm |
| stainless steel | polished (B) | H1003.012.40 | Ø12 mm |
| | | H1003.024.40 | Ø24 mm |

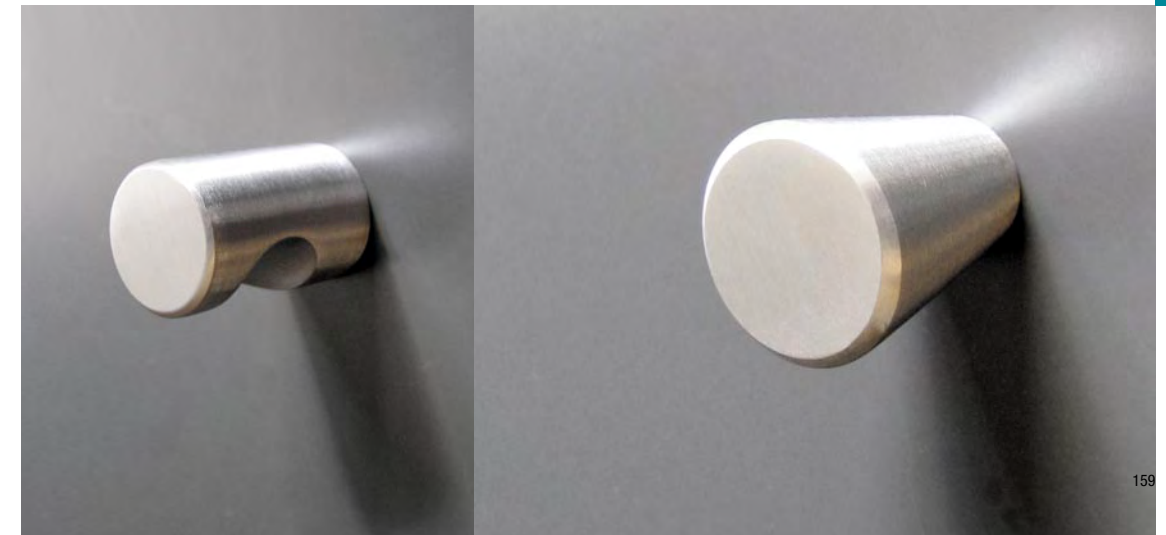

MOON Ø35MM / Ø50MM / Ø60MM / Ø65MM / Ø80MM

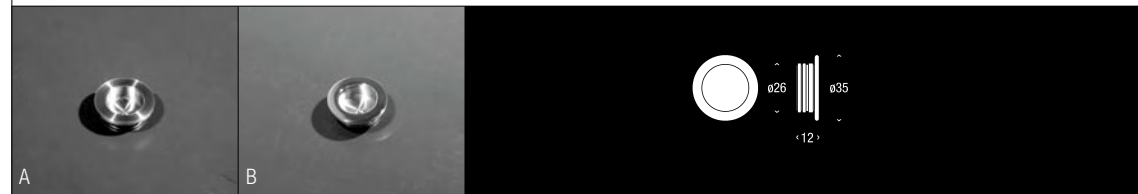

| Material | Finish | Item no. | Size |
|-----------------|--------------|--------------|--------|
| stainless steel | brushed (A) | H1024.035.01 | Ø35 mm |
| stainless steel | polished (B) | H1024.035.40 | Ø35 mm |

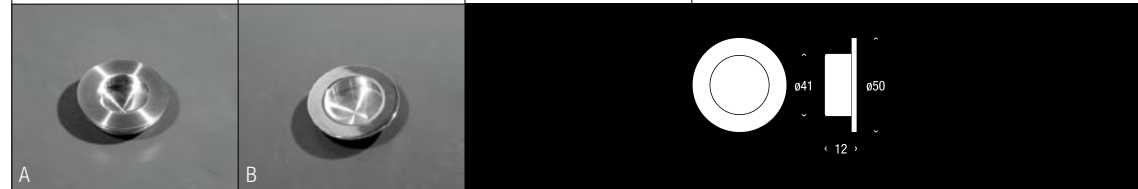

| Material | Finish | Item no. | Size |
|-----------------|--------------|--------------|--------|
| stainless steel | brushed (A) | H1024.050.01 | Ø50 mm |
| stainless steel | polished (B) | H1024.050.40 | Ø50 mm |

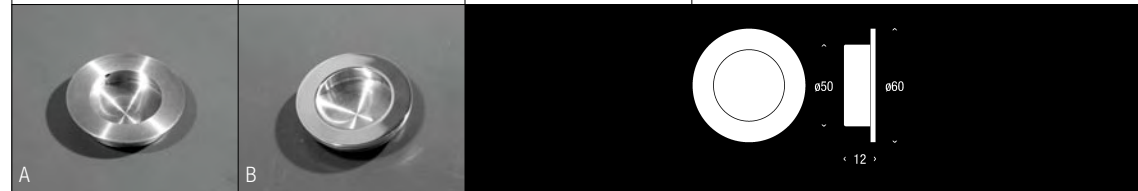

| Material | Finish | Item no. | Size |
|-----------------|--------------|--------------|--------|
| stainless steel | brushed (A) | H1024.060.01 | Ø60 mm |
| stainless steel | polished (B) | H1024.060.40 | Ø60 mm |

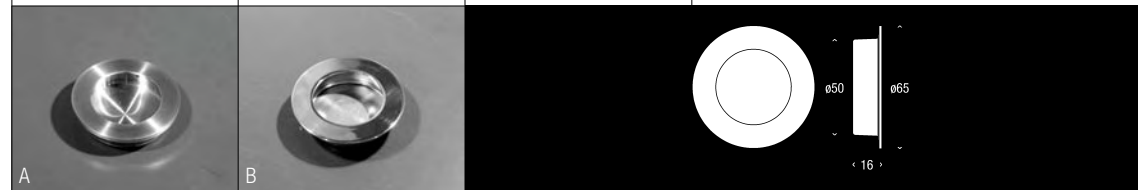

| Material | Finish | Item no. | Size |
|-----------------|--------------|--------------|--------|
| stainless steel | brushed (A) | H1022.065.01 | Ø65 mm |
| stainless steel | polished (B) | H1022.065.40 | Ø65 mm |

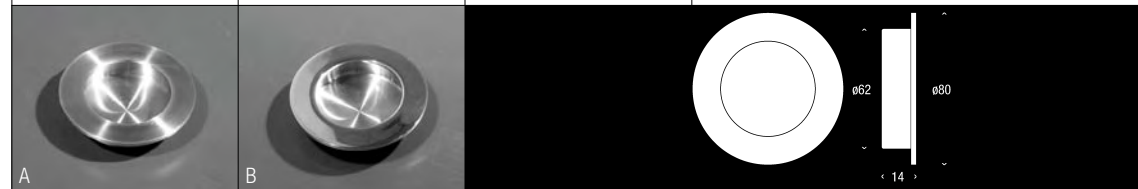

| Material | Finish | Item no. | Size |
|-----------------|--------------|--------------|--------|
| stainless steel | brushed (A) | H1024.080.01 | Ø80 mm |
| stainless steel | polished (B) | H1024.080.40 | Ø80 mm |



HALF MOON Ø90

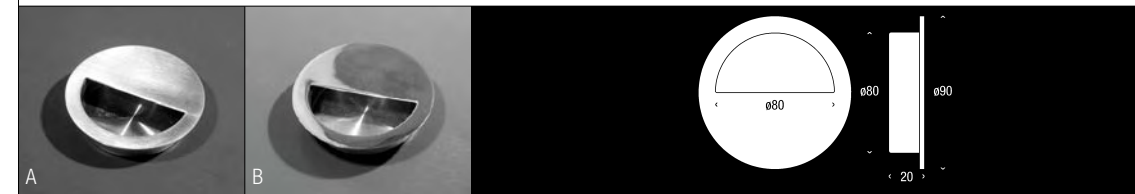

| Material | Finish | Item no. | Size |
|-----------------|--------------|--------------|--------|
| stainless steel | brushed (A) | H1023.090.01 | Ø90 mm |
| stainless steel | polished (B) | H1023.090.40 | Ø90 mm |



ELIPSE

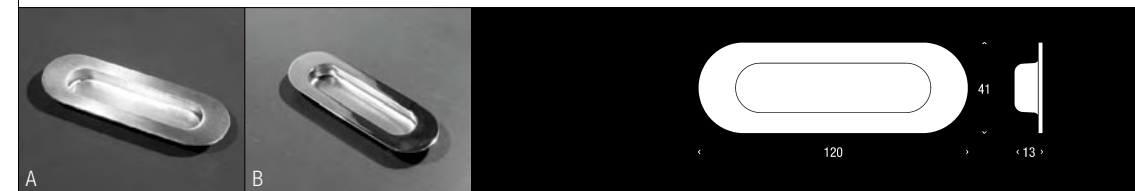

| Material | Finish | Item no. | Size |
|-----------------|--------------|--------------|--------|
| stainless steel | brushed (A) | H1021.120.01 | 120 mm |
| stainless steel | polished (B) | H1021.120.40 | 120 mm |

SQUARE 102

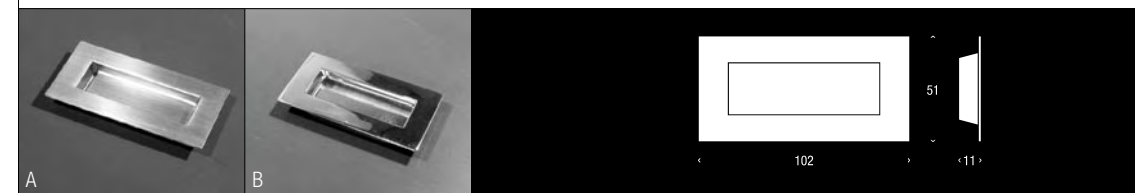

| Material | Finish | Item no. | Size |
|-----------------|--------------|--------------|--------|
| stainless steel | brushed (A) | H1020.102.01 | 102 mm |
| stainless steel | polished (B) | H1020.102.40 | 102 mm |

SQUARE 140



| Material | Finish | Item no. | Size |
|-----------------|--------------|--------------|--------|
| stainless steel | brushed (A) | H1020.140.01 | 140 mm |
| stainless steel | polished (B) | H1020.140.40 | 140 mm |

| INDEX BY ITEM NUMBERS | | | |
|-----------------------|-----------------|----------|-------------------|
| 1 | Glass Shelf 1 | page 124 | Mirrors & shelves |
| 1 | Mirror 1 | page 122 | Mirrors & shelves |
| 2 | Glass Shelf 2 | page 124 | Mirrors & shelves |
| 2 | Mirror 2 | page 122 | Mirrors & shelves |
| 3 | Glass Shelf 3 | page 124 | Mirrors & shelves |
| 3 | Mirror 3 | page 123 | Mirrors & shelves |
| 4 | Glass Shelf 4 | page 124 | Mirrors & shelves |
| 5 | Glass Shelf 5 | page 124 | Mirrors & shelves |
| 5 | Mirror 5 | page 123 | Mirrors & shelves |
| 6 | Corner Shelf | page 125 | Mirrors & shelves |
| 7 | Hall Shelf | page 125 | Mirrors & shelves |
| 1001 | Tornado | page 159 | Handles |
| 1003 | Top | page 159 | Handles |
| 1016 | Mountain Ø10mm | page 148 | Handles |
| 1018 | Beat Ø12mm | page 146 | Handles |
| 1019 | Beat Ø16mm | page 147 | Handles |
| 1020 | Square | page 161 | Handles |
| 1021 | Elipse | page 161 | Handles |
| 1022 | Moon | page 160 | Handles |
| 1023 | Half moon | page 161 | Handles |
| 1024 | Moon | page 160 | Handles |
| 1026 | Lake | page 152 | Handles |
| 1027 | Ocean | page 153 | Handles |
| 1115 | Shelf Bracket 1 | page 104 | Nova |
| 1116 | Shelf Bracket 2 | page 105 | Nova |
| 1118 | Beat Ø10mm | page 147 | Handles |
| 1118 | Towel Bar 1 | page 110 | Nova |
| 1120a | Mirror Holder 1 | page 104 | Nova |
| 1120b | Mirror Holder 2 | page 104 | Nova |
| 1121 | Towel Bar 2 | page 110 | Nova |
| 1122 | Hook 1 | page 106 | Nova |
| 1123 | Closet Rod | page 111 | Nova |
| 1124 | Hook 5 | page 108 | Nova |
| 1125 | Hook 5 x 2 | page 109 | Nova |
| 1126 | Hook 5 x 4 | page 109 | Nova |
| 1127 | Hook 4 | page 107 | Nova |
| 1128 | Hook 4 L | page 107 | Nova |
| 1131 | Hook 2 x 3 | page 106 | Nova |
| 1132 | Hook 2 x 5 | page 106 | Nova |
| 1133 | Hook 2 | page 106 | Nova |
| 1134 | Hanger 1 | page 115 | Nova |
| 1134b | Hanger 1b | page 114 | Nova |
| 1134c | Hanger 1c | page 114 | Nova |
| 1135 | Hanger 2 | page 115 | Nova |
| 1136 | Hanger 3 | page 115 | Nova |
| 1138 | Shelf Clamp 1 | page 105 | Nova |

| | | | |
|--------|--------------------------|----------|---------|
| 1139 | Shelf Clamp 2 | page 105 | Nova |
| 1149 | Shelf 2 | page 112 | Nova |
| 1172a | Hook 5 x 5 | page 109 | Nova |
| 1176 | Hall Stand 1, floor | page 116 | Nova |
| 1177 | Hall Stand 2, wall | page 117 | Nova |
| 1179 | Shelf 1 | page 112 | Nova |
| 1181 | Glass Sign Holders | page 118 | Nova |
| 1416 | Mountain Ø14mm | page 149 | Handles |
| 1801 | Feet 1 | page 119 | Nova |
| 1802 | Feet 2 | page 119 | Nova |
| 1803 | Feet 3 | page 119 | Nova |
| 1901-1 | Hook 6 | page 41 | Nova2 |
| 1901-2 | Hook 6 L | page 41 | Nova2 |
| 1901-3 | Handle 6 | page 157 | Nova2 |
| 1902-1 | Hook 6L x 2 | page 42 | Nova2 |
| 1902-2 | Hook 6L x 4 | page 42 | Nova2 |
| 1904 | Hall Stand 4, wall | page 47 | Nova2 |
| 1906 | Hook For Bar 2 | page 19 | Nova2 |
| 1907 | Hook For Bar 3 | page 18 | Nova2 |
| 1909 | Toilet Roll Holder 1 | page 31 | Nova2 |
| 1910 | Toilet Brush 1, floor | page 25 | Nova2 |
| 1911 | Toilet Brush 2, wall | page 24 | Nova2 |
| 1912 | Toilet Roll Holder 2 | page 30 | Nova2 |
| 1913 | Towel Ring 1 | page 26 | Nova2 |
| 1914 | Towel Rack | page 27 | Nova2 |
| 1915 | Dish Holder With Dish | page 38 | Nova2 |
| 1916-1 | Towel Bar 3 | page 28 | Nova2 |
| 1916-2 | Towel Bar 4 | page 28 | Nova2 |
| 1916-3 | Towel Bar 5 | page 29 | Nova2 |
| 1916-4 | Towel Bar 6 | page 29 | Nova2 |
| 1917-1 | Kitchen Rail 2 | page 11 | Nova2 |
| 1917-2 | Kitchen Rail Extension | page 10 | Nova2 |
| 1918 | Shelf 3 | page 12 | Nova2 |
| 1919 | Knife Block | page 13 | Nova2 |
| 1919-1 | Magnetic Knife Holder | page 14 | Nova2 |
| 1920 | Coffee Filter Holder 1 | page 13 | Nova2 |
| 1921 | Kitchen Roll Holder 1 | page 16 | Nova2 |
| 1921-1 | Kitchen Roll Holder 6 | page 16 | Nova2 |
| 1923 | Kitchen Roll Holder 2 | page 17 | Nova2 |
| 1925 | Cup Holder With Cup | page 38 | Nova2 |
| 1926 | Soap Dispenser 1 | page 21 | Nova2 |
| 1927 | Soap Dispenser 2 | page 36 | Nova2 |
| 1929 | Shoe Shelf 1 | page 113 | Nova |
| 1929-1 | Shoe Shelf 2 | page 113 | Nova |
| 1929-4 | Feet For Shoe Shelf | page 113 | Nova |
| 1930 | Bar Railing / Closet Rod | page 111 | Nova |
| 1931 | Door Stop 1 | page 44 | Nova2 |

| | | | |
|--------|----------------------------|----------------|---------|
| 1931-1 | Door Stop 2 | page 45 | Nova2 |
| 1932 | Mirror Holder 3 | page 32 | Nova2 |
| 1933 | Shelf Clamp 5 | page 33 | Nova2 |
| 1934 | Bath Grip | page 29 | Nova2 |
| 1935 | Hall Stand 4, floor swivel | page 46 | Nova2 |
| 1936 | Wardrobe Shelf 1 | page 49 | Nova2 |
| 1937 | Shower Shelf 1 | page 35 | Nova2 |
| 1938 | Shower Shelf 2 | page 34 | Nova2 |
| 1939 | Soap Dispenser 3, wall | page 23 | Nova2 |
| 2021 | Barcelona | page 135 / 136 | Handles |
| 2029 | Paris CC64mm | page 154 | Handles |
| 2030 | Paris CC96mm | page 154 | Handles |
| 2031 | Paris CC128mm | page 154 | Handles |
| 2032 | Paris CC160mm | page 154 | Handles |
| 2520 | Arki+ assymetrical | page 143 | Handles |
| 2520C | Arki+ symmetrical | page 142 | Handles |
| 2525 | Linea | page 155 | Handles |
| 2541 | Arki+ 188mm | page 141 | Handles |
| 2542 | Arki+ 74mm | page 140 | Handles |
| 2543 | Arki+ 74mm, reverse | page 140 | Handles |
| 2545 | Arki+ 512mm | page 141 | Handles |
| 2547 | Arki+ 45mm | page 140 | Handles |
| 2548 | Arki+ 188mm, reverse | page 141 | Handles |
| 2563 | Wall | page 133 | Handles |
| 2564 | Skyline | page 138 | Handles |
| 2565 | Tower | page 133 | Handles |
| 3001 | Shelf | page 58 | Unu |
| 3002 | Wardrobe Wall Rack | page 60 | Unu |
| 3003 | Shelf Clamp 3 | page 67 | Quadra |
| 3003 | Wardrobe Wall/Coat Rack | page 54 | Unu |
| 3004 | Shelf Clamp 4 | page 67 | Quadra |
| 3005 | Shelf Bracket 3 + 4 | page 98 | Quadra |
| 3007 | Handle 1 | page 128 | Quadra |
| 3008 | Handle 2 | page 128 | Quadra |
| 3008 | Magazine Holder, wall | page 62 | Unu |
| 3009 | Handle 3 | page 130 | Quadra |
| 3009 | Mirror With Mounting | page 58 | Unu |
| 3010 | Handle 4 | page 131 | Quadra |
| 3010 | Wardrobe Wall/Coat Rack | page 55 | Unu |
| 3011 | Hook 7 + 7L | page 92 | Quadra |
| 3012 | Hook 8 + 8L | page 94 / 95 | Quadra |
| 3013 | Hanger 4 | page 56 | Unu |
| 3013 | Hook 11 | page 93 | Quadra |
| 3014 | Toilet Roll Holder 3 | page 84 | Quadra |
| 3015 | Toilet Roll Holder 4 | page 85 | Quadra |
| 3016 | Towel Bar 5 | page 90 | Quadra |
| 3017 | Towel Bar 6 | page 90 | Quadra |

| | | | |
|-------|------------------------|--------------|---------|
| 3018 | Kitchen Roll Holder 3 | page 83 | Quadra |
| 3020 | Coffee Filter Holder 2 | page 80 | Quadra |
| 3021 | Mirror Holder 4 + 5 | page 96 | Quadra |
| 3022 | Toilet Brush 3, floor | page 86 | Quadra |
| 3023 | Toilet Brush 4, wall | page 86 | Quadra |
| 3024 | Kitchen Roll Holder 4 | page 82 | Quadra |
| 3027 | Towel Ring 2 | page 88 | Quadra |
| 3032 | Shelf 4 | page 68 | Quadra |
| 3033 | Shelf 5 | page 70 | Quadra |
| 3034 | Arki+ assymetrical | page 143 | Handles |
| 3034C | Arki+ symmetrical | page 142 | Handles |
| 3034 | Shelf 6 | page 69 | Quadra |
| 3035 | Shelf 7 | page 71 | Quadra |
| 3036 | Magnet Bar 1 + 2 | page 79 | Quadra |
| 3037 | Rails | page 74 / 75 | Quadra |
| 3038 | Hook 9 + 10 | page 76 / 77 | Quadra |
| 3039 | Soap Dish | page 72 | Quadra |
| 3040 | Cup With Lid | page 72 | Quadra |
| 3041 | Kitchen Roll Holder 5 | page 81 | Quadra |
| 3042 | Shelf 8 | page 89 | Quadra |
| 3046 | Shelf Clamp 6 | page 100 | Quadra |
| 4021 | Perth | page 159 | Handles |
| 4022 | Melbourne | page 158 | Handles |
| 4024 | Brisbane | page 158 | Handles |
| | | | |
| | | | |
| | | | |
| | | | |
| | | | |
| | | | |
| | | | |
| | | | |
| | | | |
| | | | |
| | | | |
| | | | |
| | | | |
| | | | |
| | | | |
| | | | |
| | | | |
| | | | |
| | | | |
| | | | |
| | | | |
| | | | |
| | | | |
| | | | |
| | | | |

